

Dell™ Multi-UPS Management Console ®

Installation and Configuration User's Guide

Notes

NOTE: A NOTE indicates important information that helps you make better use of your computer.

Information in this document is subject to change without notice.

© 2013 Dell Inc. All rights reserved.

Reproduction of these materials in any manner whatsoever without the written permission of Dell Inc. is strictly forbidden.

Trademarks used in this text: *Dell* and the *Dell* logo are trademarks of Dell Inc.; *Hyper-V*, *Microsoft*, *Windows*, *Internet Explorer*, *System Center Virtual Machine Manager*, *Windows Server*, *Windows 7*, *Windows XP*, and *Windows Vista* are either trademarks or registered trademarks of Microsoft Corporation in the United States and/or other countries; *Eaton* and *ePDU* are registered trademarks of Eaton Corporation; *Intel*, and *Xeon* are registered trademarks and *Core* is a trademark of Intel Corp.; *Mozilla* and *Firefox* are registered trademarks of the Mozilla Foundation; *Linux* is a registered trademark of Linus Torvalds; *Red Hat* is a registered trademark of Red Hat, Inc.; *VMware*, *vSphere*, *vMotion*, *vCenter*, *ESX*, and *ESXi* are trademarks or registered trademarks of VMware, Inc.; *Citrix*, *Xen*, *XenServer*, *XenClient*, *XenCenter*, and *XenMotion* are either registered trademarks or trademarks of Citrix Inc.; *Google* and *Chrome* are trademarks or registered trademarks of Google, Inc..

Other trademarks and trade names may be used in this document to refer to either the entities claiming the marks and names or their products. Dell Inc. disclaims any proprietary interest in trademarks and trade names other than its own.

November 2013 • P-164000119 2

Table of Contents

1	Introduction	
2	Installation	
	Installation Prerequisites	17
	On the System Hosting Dell MUMC	17
	On the System that Displays the Web-based GUI	17
	Quick Start Installation	18
	Graphical Installation	18
	Configuration	19
	Operation	20
	Installation Result	22
	Uninstalling the Dell MUMC (Standard Methods)	22
	Installing/Uninstalling the Dell MUMC (Command Line)	22
	Upgrading the Product	23
3	Configuration	
	Node Configuration and Console Settings	24
	Discover Nodes Connected on the Network	24
	Configure Actions	25
	Configure User Accounts	33
	System Settings	34

4 Supervision

Access to the Monitoring Interface	36
Local Access	36
Remote Access.	36
Node List View	37
Flexible Panels View	39
Panels List	41
Information Panel	41
Status Panel	42
Outlets Panel	43
Measures Panel	44
Environment Panel	45
Graph Panel	45
Synoptic Panel	46
Events Panel	50
Statistics Panel.	50
Power Components	51
Device Supervision	51
Applications List View	52
Map View	53
Create a Customized Map View	53
Map Examples	54
Events	58
List Representation.	58
Calendar Representation.	59
Nodes Events List	60
Launching Device Web Interface	63
Defining Sub-views	63
Sharing Sub-views	65

5	Shutdown	
	Shutdown Configuration	67
	Shutdown through Hibernate	69
	Power Source View	70
	Shutdown Sequence	71
6	Advanced Management	
	Nodes Settings	72
	Single Node Configuration Display	72
	Single Card Settings	73
	Multiple Cards Configurations Synchronization	74
	Nodes Upgrade	75
	Upload Device Firmware	75
	Upgrade Applications	76
7	Virtualization	
	Dell Multi-UPS Management Console Virtualization Solutions for VMware, Microsoft, Citrix, OpenSource Xen, and KVM	80
	Dell Solutions for VMware	80
	Dell Solutions for Microsoft	82
	Dell Solutions for Citrix Xen	83
	Dell Solutions for OpenSource Xen	85
	Dell Solutions for Red Hat KVM or OpenSource KVM	86
	Dell Solutions for Citrix XenClient	87
	Tested environments	88
	VMware	88
	Microsoft	88
	Citrix	88
	Enabling the Virtualization Module	88

VMware Supervisors Prerequisites	89
Microsoft Supervisors Prerequisites	89
Citrix Supervisors Prerequisites	90
Adding Manager or Hypervisor List	90
Introduction	90
Adding a vCenter Server Manager	91
Adding a SCVMM Manager	91
Adding a VMware ESX/ESXi Hypervisor List	92
Adding a Citrix XenServer Hypervisor List	92
Adding a XenCenter	93
Configuring Hypervisors (ESX/ESXi Server, XenServer)	93
Introduction	93
Credential Configuration for the Hypervisors (ESX/ESXi, XenServer)	94
Configuring Maintenance and Shutdown	94
Introduction	94
Configuration Options for vCenter and SCVMM Installations	94
Second Type of Nodes (DELL MUMC Detects Dell ULNM Running on the VMHost)	97

8 Redundancy

Redundancy Configuration	100
Redundancy Views	101
Redundancy View in Node List	101
Composite Device in Power Source View	102
Power Components Sub-view	102
Redundancy Use Cases	103

9	Applying Extended Functionality	
	Configuring the Dell MUMC vCenter Plugin	108
	Checking for vCenter Plug-in Registration.	108
	Events and Alarms	109
	Using Dell MUMC through vCenter	110
	Configuring XenCenter Plug-in	111
	Prerequisites	111
	Check XenCenter Plug-in Installation	111
	Using Dell MUMC through XenCenter	113
	Configuring Maintenance Mode and vMotion with vCenter	113
	Prerequisites	113
	Introduction	113
	Understanding Maintenance Mode	114
	Configuring Maintenance Mode Behavior in vCenter.	114
	Configuration Test	115
	VMware vCenter High Availability	115
	Configuring Maintenance Mode and Live Migration with SCVMM	116
	Maintenance Mode	116
	Understanding Live Migration	116
	Configuration Test	116
	VMware References	117
	Dell and Virtualization	117
	VMware ESX Configuration	117
	vCenter Server (VMware Supervisor)	117
	vSphere SDK for Perl.	117
	Microsoft Hyper-V References	117
	Dell and Virtualization	117
	Microsoft TechNet Library.	117
	About Maintenance Mode.	117
	Requirements for Using Live Migration	117

Introduction

Dell™ Multi-UPS Management Console® (MUMC) is ideal for monitoring and managing multiple power and environmental devices. The Dell MUMC delivers a global view across the network from any PC with an Internet browser. Exceptionally versatile, the software is compatible with any device that supports a network interface, including other manufacturer’s UPSs, environmental sensors, Power Distribution Units (PDUs), applications, and more. The Dell MUMC can also organize a management table by groups, centralize alarms, and maintain events logs for preventive maintenance of the entire installed equipment base.

The Dell MUMC provides the following:

- Discovers and supervises Dell UPSs and Dell PDUs connected to the network either by means of a card or a proxy. For the detailed list of compatible solutions, see “Compatibility” on page 10.
- Supervises the remote servers hosting the Dell MUMC application.
- Provides advanced management feature (mass configuration and mass upload) with the Dell™ Network Management Card (H910P, also known as an NMC).
- Provides local computer graceful shutdown through the Dell Network Management Card.
- Provides an agentless method for directly managing and controlling VMware® hypervisors through the VMware® vCenter™ management platform
- Provides centralized management of Dell™ UPS Local Node Manager® (ULNM) applications running on virtualized servers other than VMware vCenter (such as Microsoft® Hyper-V™ hypervisor or Citrix® Xen®).

Figure 1 shows the Dell MUMC Node Map Page.

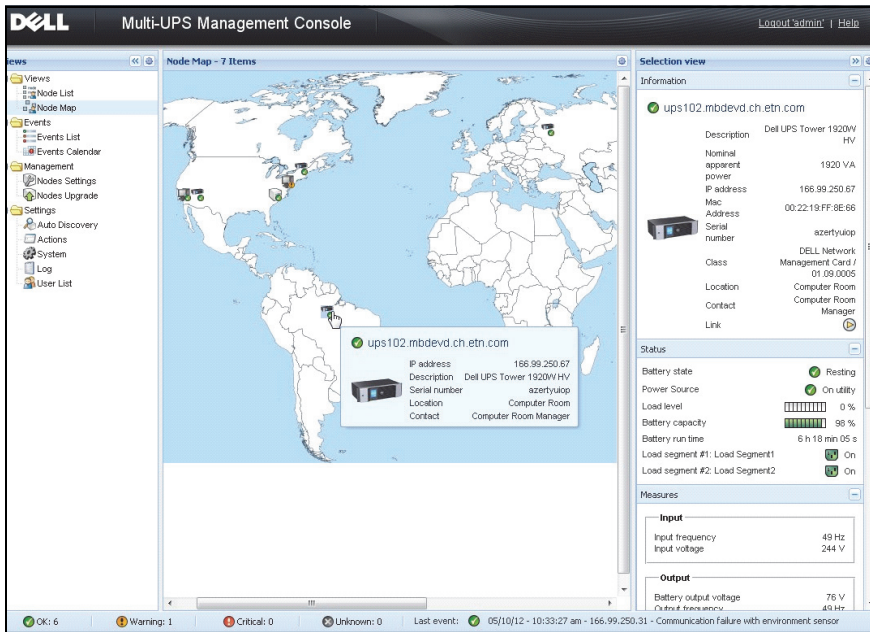

Figure 1. Dell MUMC Node Map Page

Compatibility

Serial Line Devices

The Dell MUMC is compatible with the following serial line devices (see Table 1).

Table 1. Serial Line Devices

Dell Equipment Designation	Connectivity Type
500 Watt, 1000 Watt, 1920 Watt, 2300 Watt, 2700 Watt Rack/Tower	USB or RS-232
Short Depth High Efficiency Online 2700 Watt	USB or RS-232
High Efficiency Online 3750 Watt, 4200 Watt, 5600 Watt	USB or RS-232
LI 5600 Watt Rack	USB or RS-232
Online 10 kW Rack	USB or RS-232

Network Devices

The Dell MUMC is compatible with the following network device (see Table 2).

Table 2. Network Device

Dell Equipment Designation	Network Device Type
Dell Network Management Card SNMP/Web H910P	UPS Option Card



Dell Applications

The Dell MUMC is compatible with the following applications (see Table 3).

Table 3. Applications







Equipment Designation	Application Type
Computers (Microsoft® Windows® - Linux®) hosting the Dell ULNM Shutdown Controller Features: <ul style="list-style-type: none"> • Quick Scan • Supervision • Management • Shutdown 	UPS Proxy (Shutdown Controller) 
Computers (Windows - Linux) hosting the Dell ULNM Application Features: <ul style="list-style-type: none"> • Quick Scan • Supervision • Management 	 
Dell PDUs Features: <ul style="list-style-type: none"> • Quick Scan • Supervision 	 

Table 3. Applications (Continued)

Equipment Designation	Application Type
Eaton® ePDU® Monitored & Advanced Monitored Feature: <ul style="list-style-type: none">• Supervision	
Eaton ePDU Managed Feature: <ul style="list-style-type: none">• Supervision	
Eaton ePDU Switched Feature: <ul style="list-style-type: none">• Supervision	

Dell ULNM Management

The Dell ULNM can be remotely managed, configured, and updated using Dell MUMC supervisory software. Using the Dell MUMC, you can perform mass configurations and mass updates of Dell ULNM applications. The Dell MUMC can also remotely perform the following:

- Display a Dell ULNM Release 2 configuration
- Configure a single Dell ULNM Release 2
- Synchronize multiple Dell ULNM Release 2 configurations
- Trigger Dell ULNM Release 2 instances upgrade

Performance Evaluations

To provide a performance evaluation, Dell has tested the following configurations:

Test with Machine 1 (server Dell PowerEdge 2900)

- CPU: Intel® Xeon® 5130 dual-core @2GHz
- Memory: 2Go DDR2 @666MHz
- HDD: 2 HDDs 67GB 7200 rpm RAID 0 (Mirroring)
- OS: Microsoft® Windows Server® 2008 64 bits

Test conditions during 40 hours:

- 1300 nodes (including ~50 real), mainly Dell MUMCs, and some NSM and Dell Network Management Card.
- Average CPU load: 20~30%
- Memory load: 200~300MB

Test with Machine 2 (typical PC)

- CPU: Intel Core™ 2 Duo 6600 @2.4GHz
- Memory: 2Go DDR2
- HDD: 1 HDD 220 GB 7200 rpm
- OS: Microsoft® Windows Vista® Enterprise 32 bits

Test conditions during 40 hours:

- 1000 nodes (including ~50 real), mainly Dell MUMCs, and some NSM and Dell Network Management Card.
- Average CPU load: ~ 60%
- Memory load: 200 ~300MB

NOTE: These tests have been performed on Windows Server Operating System. The Windows 2003 or 2008 Operating Systems do not have the limitation of 10 simultaneous connections.

Network Ports

Table 4 lists the network ports used by the Dell MUMC.

Table 4. Network Ports

Protocol	Mode Port	Dell ULNM and Dell MUMC	Dell UPS Management Card
SMTP	TCP/25	OUT	OUT
DHCP/BOOTP	UDP/67	X	OUT
TFTP	UDP/69	OUT	IN
HTTP	TCP/80	OUT	IN
NTP	UDP/123	X	OUT
SNMP	UDP/161	OUT	IN
SNMP Traps	UDP/162	X	OUT
UNMP	UDP/200	IN/OUT	X
HTTPS	TCP/443	OUT	IN
Dell Supervision	TCP/4679	IN/OUT	X
Dell Notification Broadcast	UDP/4679	IN/OUT	IN/OUT
Dell SSL Supervision	TCP/4680	IN/OUT	X
Dell Alarms Broadcast	UDP/4680	IN	OUT
Dell Connected Alarms	TCP/5000	OUT	IN
Dell Connected Alarms	TCP/5001	OUT	X

Troubleshooting

HTML pages

Cannot display the UPS properties page. HTTP 404 error with IE.

Solution:

- Check the URL entered.
<https://<name or IP of the computer hosting Dell MUMC>:4680/>
or
<http://<name or IP of the computer hosting Dell MUMC>:4679/>

Terms

This section provides related terms and definitions.

IP address

When Transmission Control Protocol / Internet Protocol (TCP/IP) is installed on a computer, an Internet Protocol (IP) address is assigned to the system. Each address is unique and is made up of four numbers, each between 0 and 256, such as 168.8.156.210.

Network Management Proxy

Network Management Proxy is used to control a UPS and connect it to the TCP/IP network.

Network Management System

The Network Management System (NMS) supervises SNMP devices connected to the TCP/IP Network.

Network Shutdown Module

The Network Shutdown Module is a software module that uses the information transmitted by the Dell Network Management Card/Proxy to inform computer users on the current status of the electrical power supplied to the computer.

If the supply of the electrical power from the UPS is at risk, the Network Shutdown Module initiates an orderly shutdown of the computer under the most secure conditions possible.

RSA Algorithm

An algorithm for public-key cryptography encryption protocol. An RSA key is the result of operations involving prime numbers. RSA refers to Ron Rivest, Adi Shamir, and Leonard Adleman, who described public-key cryptosystems in 1978.

Secure Socket Layer

The Secure Socket Layer (SSL) is a solution for securing transactions over the internet. SSL is a communication protocol that authenticates the data exchanged, as well as ensuring its confidentiality and integrity. The protocol uses a recognized encryption method, the RSA algorithm with a public key. SSL is built into Internet Web browsers. The padlock in the bottom of your browser screen is automatically displayed if the server sending information uses SSL.

Transmission Control Protocol / Internet Protocol

TCP/IP is a family of network and communication protocols for the transport and network layers. Also known as the Internet Protocol suite of network communication protocols.

Acknowledgements

The Dell software development team is grateful to the following projects:

- Spider Monkey
- Ext JS
- SQLite
 - The SQLite Project (<http://www.sqlite.org/>) generously donated source code to the public domain that helped us for this project.
- Open SSL
 - This Dell MUMC product includes software developed by the OpenSSL Project for use in the OpenSSL Toolkit (<http://www.openssl.org/>).
 - This Dell MUMC product includes cryptographic software written by Eric Young (ey@cryptsoft.com).
 - This Dell MUMC product includes software written by Tim Hudson (tjh@cryptsoft.com).
- Lib USB
- Net SNMP

The full license version for each of these projects is available from Dell MUMC using the **Settings > System > About** selection path.

Installation

This chapter provides Dell Multi-UPS Management Console (MUMC) installation prerequisites, quick start installation procedures, and command line procedures. Procedures for uninstalling and upgrading the product are also included.

Installation Prerequisites

This section provides installation prerequisites for the following:

- Systems hosting the Dell MUMC
- Systems that display the Web-based graphical user interface (GUI)

On the System Hosting Dell MUMC

The Dell MUMC can be installed on Microsoft® Windows XP®, Microsoft® Windows Vista® 7, and on Microsoft® Windows Server® 2003 and 2008 (including R2 revision).

- For better performances with multiple nodes, Dell recommends a Microsoft® Windows Server® OS (that does not have the limitation of 10 simultaneous connections)
- To avoid network or serial port access conflicts, you can't install the Dell MUMC on a machine that also hosts:
 - Dell UPS Management Software

NOTE: This is the previous Dell software for managing UPSs. If you were using it previously, remove it before installing the new Dell MUMC software)

- Dell MUMC

On the System that Displays the Web-based GUI

The Dell MUMC graphical interface can be accessed remotely using a simple Web browser. Access to this interface can be secured through Secure Socket Layer (SSL) connection and is also secured through login and password.

The Dell MUMC graphical interface has been tested with:

- Google® Chrome™
- Mozilla Firefox® 3.0, 3.5
- Microsoft® Internet Explorer® 6(*), 7, 8, 9 (* IE6 should work but the performance is not optimal).

Quick Start Installation

This section includes quick start installation and configuration instructions.

Graphical Installation

To install the Dell MUMC:

- 1 On a Windows XP, Vista 7, or on a Windows Server 2003 and 2008 machine, run the Dell Multi-UPS Management Console package under an administrator account. A Web browser displays the Dell Multi-UPS Management Console Installer Welcome screen.
- 2 Observe the prompt and verify that the communication device is connected. Click **Next** (see Figure 2). The Login screen displays.



Figure 2. Welcome Screen

- 3 Read the application description. Type the login and password and click **Login** (see Figure 3).

 **NOTE:** The default entry for login and password is **admin**.



Figure 3. Login Screen

Configuration

When started, the application automatically performs a discovery using the “Quick Scan” option:

- Using the “Quick Scan” operation, you will discover, through broadcast, within a few seconds, all Dell UPS Management Cards, Dell PDUs, and Dell UPS Local Node Manager (ULNM) (or Dell ULNMs) on the local subnet network.
- The discovered nodes are displayed using **Settings > Auto Discovery** (see Figure 4).
- For the other nodes, perform the discovery based on IP address ranges using the “Range Scan” option. Using “Range Scan” discovers the nodes that are outside of the network segment and nodes that are not compatible with the “Quick Scan” feature.
- Refer to the Compatibility list to determine if your node supports “Quick Scan” feature.

(Optional) If you want the computer running Dell MUMC to shut down in the event of a power failure: Use **Settings > Shutdown > Module Settings** to activate the shutdown module.

From the **Settings > Shutdown** page, assign the following:

- IP address of the UPS that powers the local Computer
- The access parameters through the login and password entries.

License Code

The Dell MUMC monitors up to 32 devices (including Dell UPSs, Dell PDUs, and Dell Network Management Card) without a license key.

If there are more devices to be monitored, an appropriate license is needed. The license can also be upgraded later without reinstallation.

For “Silver” or “Gold” paid versions:

- In **Settings > System > Edit System Information**, enter the license product key provided:
 - Dell MUMC Silver License (33 to 100 device nodes)
 - Dell MUMC Gold License (101 to unlimited devices nodes)

NOTE: Nodes that are not managed due to license limitation will appear with this icon: 

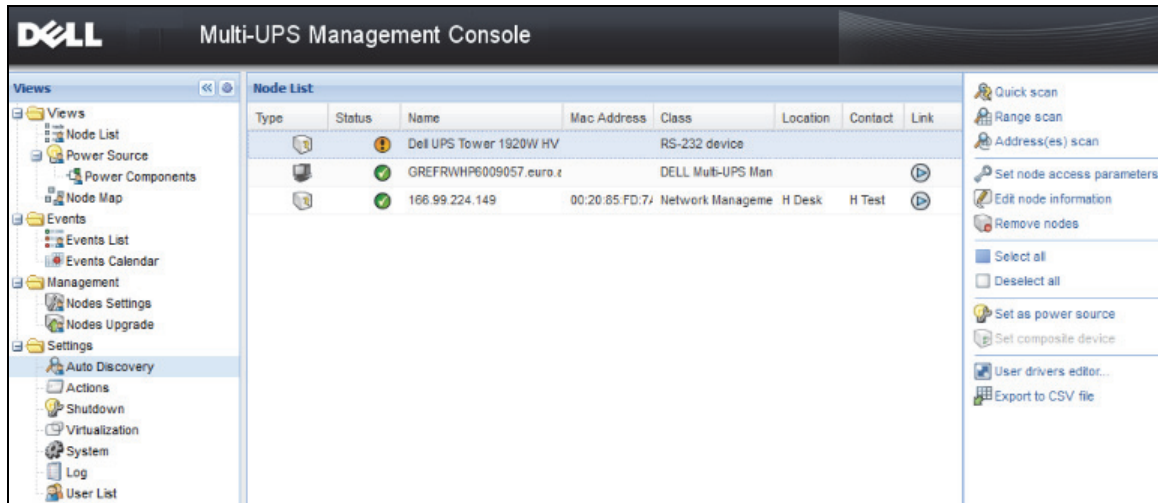

Figure 4. Quick Start - Auto Discovery

Operation

The **Views > Node** menu item allows you to supervise the current state of the compatible power devices and application. Select a line in the list and the panels are updated with selected device information (see Figure 5).

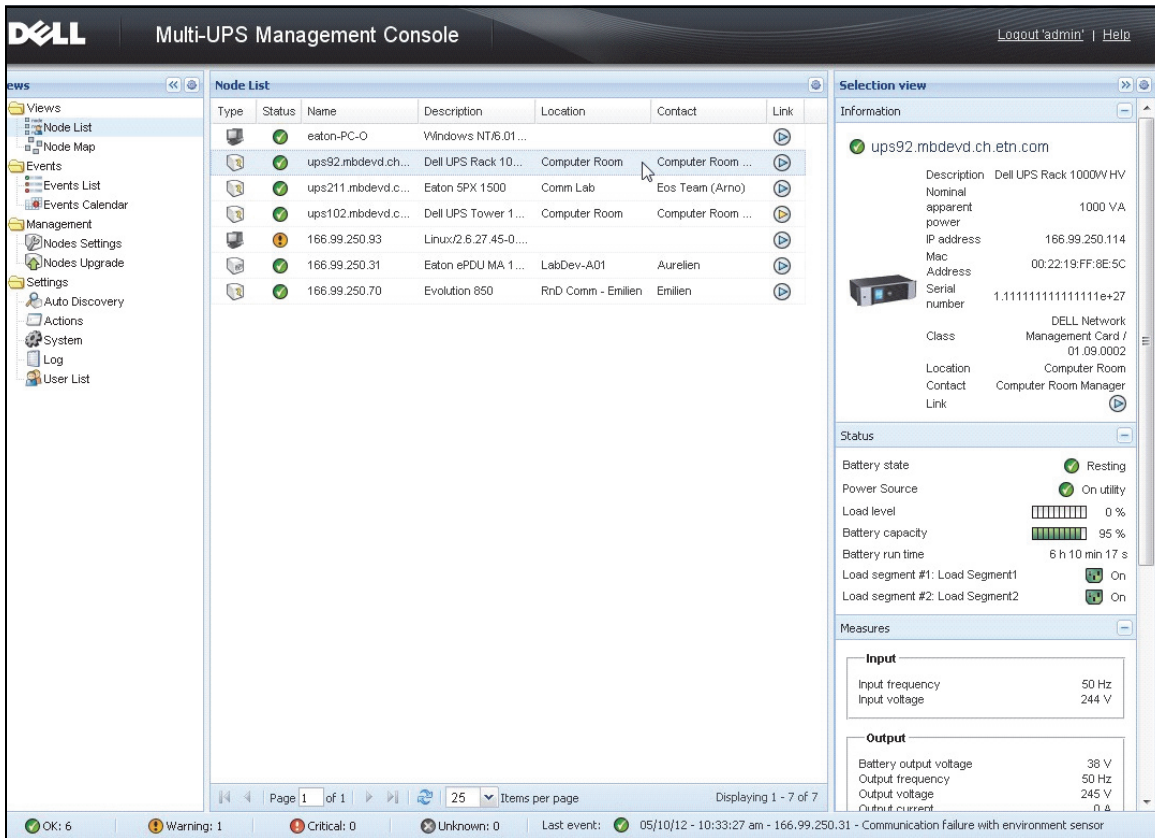

Figure 5. Quick Start -Node Information in Selection View

[Optional] If you have enabled the Shutdown module:

- The **Views > Power Source** menu item allows you to supervise the current state of the UPS nominated as power source in the Shutdown optional module.
- The **Events > Event List** view allows you to view the device events.

Installation Result

If you install a new Dell MUMC release without uninstalling the old one, you will keep your database and your product settings.

- At the end of the installation, the following shortcuts are created in the group **Start > Programs File > Dell > Multi-UPS Management Console**:
 - **Open Dell Multi-UPS Management Console**: Starts the main Dell MUMC graphical interface
 - **Start Dell Multi-UPS Management Console**: Starts the service
 - **Stop Dell Multi-UPS Management Console**: Stops the service
 - **Uninstall Dell Multi-UPS Management Console**: Uninstalls the program
- A service called “Dell Multi-UPS Management Console” is also created for the Database Acquisition Engine.
 - This service automatically starts on machine boot-up.
 - This service provides the Web Interface.
- A System Tray Icon displays the alarms on the local computer. Right-click this icon to display the same shortcuts as the Windows Start menu.

Uninstalling the Dell MUMC (Standard Methods)

Two standard methods for uninstalling the Dell MUMC are available:

- From the Add/Remove programs item of the control panel, select the **Dell Multi-UPS Management Console Vx.xx** package to remove it.
- You can also uninstall from the shortcuts to remove the product and custom files (if you confirm the action):
Start > Program File > Dell > Multi-UPS Management Console > Uninstall Multi-UPS Management Console

This will allow you to remove the database and custom files if you confirm that choice.

Installing/Uninstalling the Dell MUMC (Command Line)

You can install or uninstall the product from a command line in order to deploy the software in a group, with or without using the graphical interface. This method also provides the ability to configure protection settings from the command line.

- Detail of available command options can be obtained using command:
 - `<packageName> -help`
 - `<packageName> [COMMAND] [OPTION]...`
- The available commands are:
 - `-install` Launches the installation/upgrade process (default).
 - `-uninstall` Launches the process to uninstall the application.

- The available options are:
 - -debug Displays debugging information on the console.
 - -silent Install the application silently.
- Access the installation folder:
 - -dir <installPath>

Example

The command <packageName> -install -silent -dir "C:\Program Files\MyFolder" will install Dell MUMC silently in C:\Program Files\MyFolder.

After the installation is completed, open a Web browser with the following URL:

http://<host>:4679/, *where* <host> is the host name or IP address of the machine hosting Dell MUMC.

Upgrading the Product

If you install a new Dell MUMC Release without uninstalling the old release, you will keep the database and product information from the old release.

Configuration

This chapter describes how to configure the Dell Multi-UPS Management Console (MUMC).

Node Configuration and Console Settings

Each node [Dell UPS Management Card, a Dell PDU, or Dell UPS Local Node Manager (ULNM)], must have a valid IP address (or a DNS name) in the range that you have entered for auto-discovery. (See “Compatibility” on page 10.)

Dell MUMC automatically receives the alarms (through notification or polling) without specific configuration on the network card, proxies or applications.

For SNMP acquisition, check the community name.

- Default community name is configured in **Settings > System > Default Community Name**.
- A specific community name can be defined for each IP range in **Settings > Auto Discovery > Range Scan > Password**.

Discover Nodes Connected on the Network

- 1 Start the “Dell Multi-UPS Management Console” main graphical interface from the previously created shortcut.
- 2 Select the **Settings > Auto Discovery** menu item.

From **Settings > Auto Discovery**, the following discovery methods are available (see Figure 6):

- “Quick Scan” (automatically performed when application starts)
- “Range Scan”
- “Address Scan”

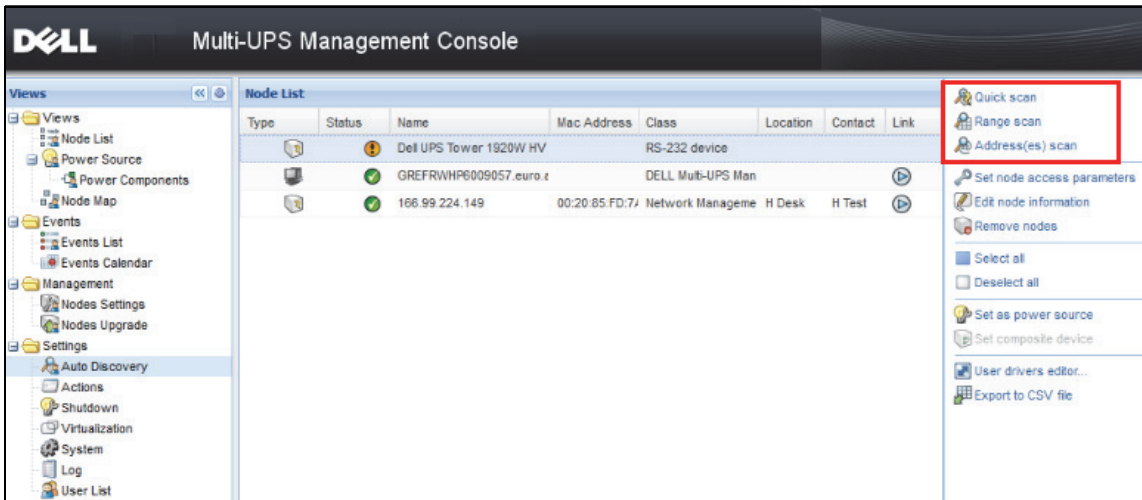

Figure 6. Auto Discovery Method Buttons

The following operation notes apply when discovering nodes:

- The “Quick Scan” request is a Broadcast frame on 4679 IANA reserved port and 69 standard TFTP port. Using the “Quick Scan” operation, you will discover through broadcast within a few seconds following Web/SNMP cards.
- For the nodes outside of the network segment, perform the discovery based on IP address ranges using the “Range Scan” option. Using the “Range Scan” operation you will discover the nodes that are outside of the Network segment and nodes that are not compatible with the “Quick Scan” feature.
- “Address Scan” performs a single address scan (or several IP addresses separated by the ';' character)

Configure Actions

You can define the way users will be notified when node events happen.

From the **Settings > Actions** menu item selection, the Actions page displays. The following buttons are provided (see Figure 7):

- Create a new action
- Copy selected action
- Edit selected action
- Test selected action
- Remove selected action

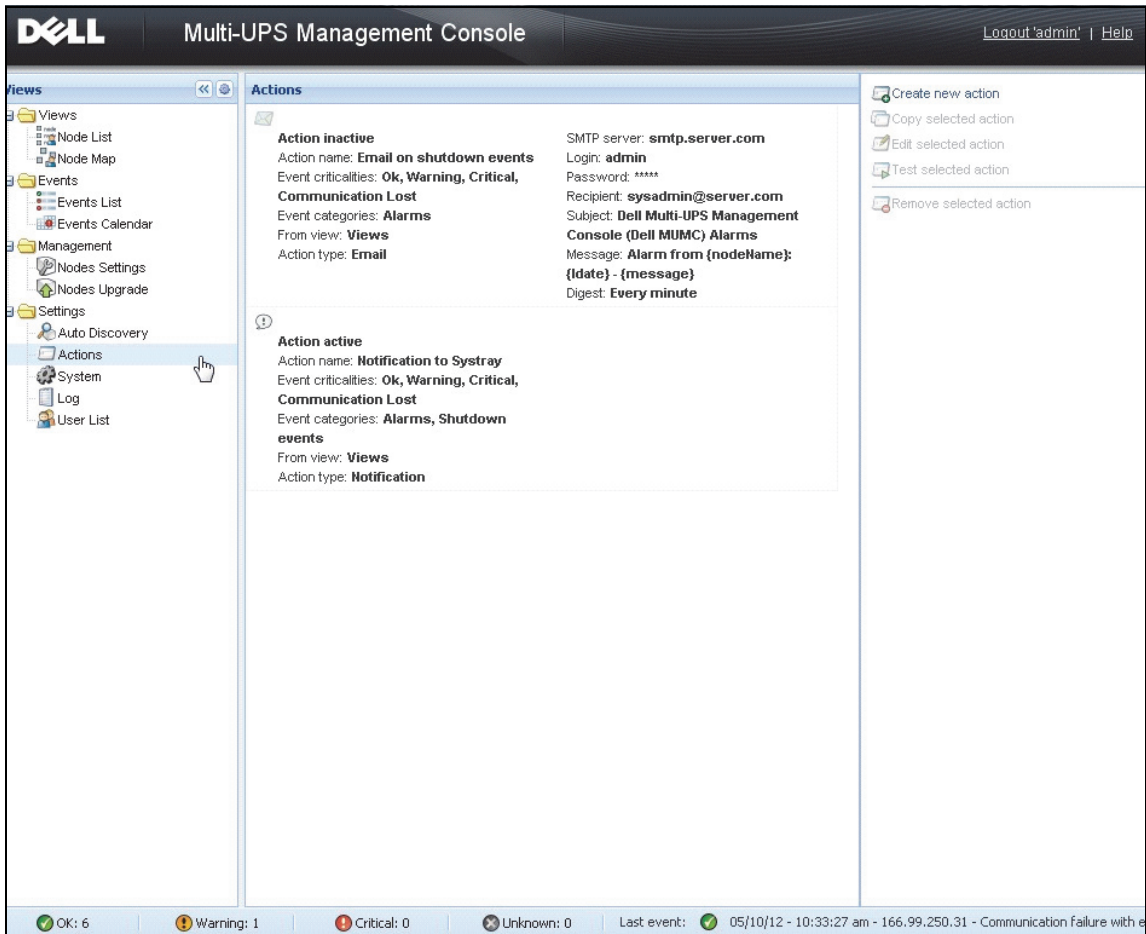

Figure 7. Actions Page

Create a New Action

Using the Create a new action button, you can filter the action by selected event criteria and use settings to define the action to respond as follows

- **Send e-mail:** Respond to the action with e-mail
- **Execute script/program:** Execute a script or program on UPS events
- **Send alarm notification:** Send a notification to the local alarm notification box, available from the System Tray icon

The Create a new action button displays the Create new action dialog (see Figure 8).

The screenshot shows a 'Create new action' dialog box with the following fields and values:

- Action active*:
- Action name*:
- Event criticalities*:
- Event categories*: (with a pencil icon)
- From view*: (dropdown)
- Action type*: (dropdown)
- Settings section:
 - SMTP server*:
 - SMTP port*: (highlighted with a red box)
 - Login:
 - Password:
 - Recipient*:
 - Sender:
 - Subject: (with a pencil icon)
 - Message: (with a pencil icon)
 - Digest*: (dropdown)

Buttons: Save, Cancel

Figure 8. Create New Action Dialog Box

NOTE: The "*" fields are required.

Events Filter

You can filter the action according to:

- Event criticalities: Critical, Warning, Normal, Communication Lost

NOTE: With this parameter, you can filter the notification according to the event level. Refer to the event list provided later in this document. If you select "Critical" as filter you will not receive the associated "Normal" event informing that the device status changes from "Critical" to "Normal."

- Event category: All Events, Alarms, Shutdown events, Power events, Measures

NOTE: The pen icon allows editing and selecting the event category.

- View: The view that triggers the event

Email

To receive email on UPS events:

- You have to indicate the SMTP server address and recipient email address. Login and password are used when SMTP server requests authentication.

For advanced use:

- You can customized the subject, such as when you use third-party service provider to translate email into SMS.
- You can specify that you want to receive a consolidation of the alarms that occurred during a delay time duration that you choose.

For example, if you specify none, each alarm will generate an email. With this setting, you will receive more email for the same number of events.

Execute Script/Program

To execute a program on UPS events, the program path will be required.

NOTE: The program is executed under the SYSTEM account.

- If an action (script or program) cannot be executed under the SYSTEM account, it is necessary to modify the execution context before it can be run.
- To allow a user to run specific tools and programs with permissions that are different from those assigned to the user's account, use the Windows "RunAs" command. This allows you to save the password (Windows XP Service Pac 2 and more recent versions).

- Use the following Microsoft command:

```
> runas /profile /user:<windows_ login> /savecred <DELL_MUMC  
INSTALLATION_PATH\mc2.exe>
```

- When first executed, a password is required; it is saved for subsequent executions.

Alarm Box Notification

The alarms are displayed on the local computer in an alarm box (see Figure 9). The status part of the alarm box is optional. It only appears if a Power Source has been declared in the Shutdown configuration.

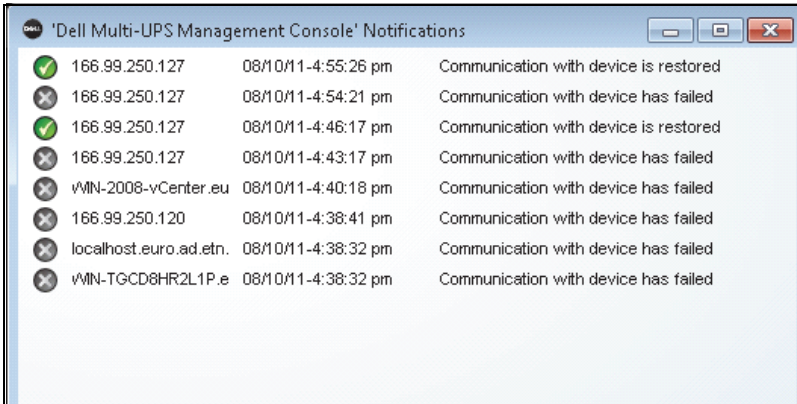



Figure 9. Alarm Notification Box

The Systray provides access to the alarm box. Right-click the System Tray icon for fast access to the functions. If no Power Source has been declared, the System Tray Icon can have the states described in Table 5.

Table 5. System Tray State Icons (Power Source not Declared)

Icon	State Description
	The System Tray Icon correctly receives alarms from Dell MUMC.
	Communication is lost between Systray and the Dell MUMC.

If a Power Source has been declared, the System Tray Icon can have the states described in Table 6.

Table 6. System Tray State Icons (Power Source Declared)





Icon	State Description
	The System Tray Icon correctly receives alarms from Dell MUMC. AC is present on the Power Source.
	The System Tray Icon correctly receives alarms from Dell MUMC. The Power Source runs in battery mode.
	The System Tray Icon correctly receives alarms from Dell MUMC. A Warning event occurred on Power Source.

Table 6. System Tray State Icons (Power Source Declared) (Continued)

Icon	State Description
	The System Tray Icon correctly receives alarms from Dell MUMC. A critical event occurred on Power Source.
	Communication with Power Source has failed.

Advanced Events and Actions Customization

In Dell MUMC installation folder, there is a configs/scripts folder containing a sample user-defined action script (**sample_user_script.js**).

You can modify this script or create new scripts that define very specific events and actions. The sample script provides details about the expected structure and syntax for defining new actions and triggers.

To activate the execution of a script, set the enabled property to true as follows:

```
UserScript =  
{  
  name: "MyScript",  
  enabled: true, // Set this property to true to enable the script  
}
```

Sample Scripts found in {INSTALLATION_PATH}/configs/scripts

Sample script: **windows_event.js**

This is a sample user script for Windows Event Logs. It allows the software to write in the local windows event log (Utility Failure/Utility Restored events). It is enabled by default.

The bolded attributes can be modified as follows:

```
UserScript =  
{  
  name: "WindowsEvents",  
  enabled: true, // Set this property to true to enable the script  
  onEvent: true,  
  delay: 0, // This property can be used to delay first execution of  
the script  
  interval: 10000, // and at an interval of every 10 seconds after  
that
```

Sample script: **humidity_shutdown.js**

This is a sample script to trigger a humidity or temperature alarm from a PDU and launch a shutdown sequence. This script illustrates what can be done with PDU probes.

The bolded attributes can be modified as follows:

```
UserScript =
{
  name: "ShutdownByTemperatureOrHumidity",
  enabled: false, // Set this property to true to enable the script
  onEvent: true,
  delay: 0, // This property can be used to delay first execution of
the script
  interval: 10000, // and every 10s from that

...

  /// @property {Integer} pduName This property is PDU ip address
with humidity sonde which must be checked
  pduName : "178.222.223.224",

  /// @property {Integer} pduHumidityLimit This property is value
limit of humidity before shutdown.
  pduHumidityLimit : 20,

  /// @property {Integer} pduTemperatureLimit This property is value
limit of temperature before shutdown.
  pduTemperatureLimit : 20,
```

Advanced Sound Alarm Customization

To configure sound alarms on events:

- 1 In the file {INSTALL DIRECTORY}\Dell\MultiUPSManagementConsole\configs\config.js, change the configuration as follows:

```
'systray':
{
  'soundAlarm': false,
  'notificationIcon': true,
  'notificationBox': true
}
```

2 Change `'soundAlarm': false`, to `'soundAlarm': true`, as shown below:

```
'systray':  
{  
  'soundAlarm': true,  
  'notificationIcon': true,  
  'notificationBox': true  
}
```

3 Close and restart the Windows user session so that this configuration is taken into account

NOTE: You can change the alarm sound by setting the Windows sound preferences from Control Panel (see Figure 10).

NOTE: The Dell MUMC alarms are linked to the “Low Battery Alarm” sound that you can change by selecting another wav file.

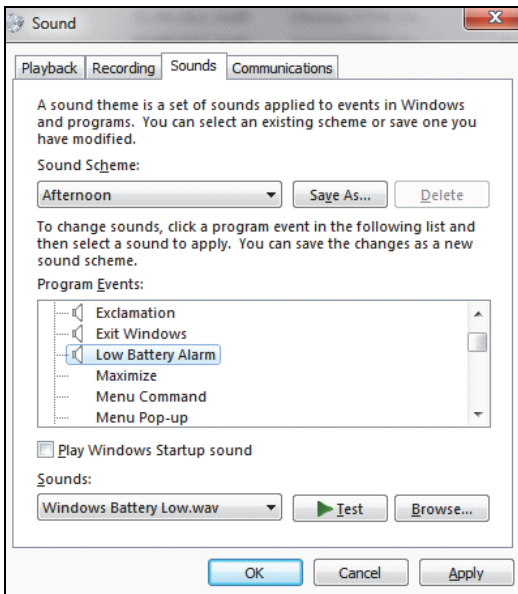

Figure 10. Sound Alarm Choice

Configure User Accounts

To configure multiple user accounts:

- 1 Login with an administrator user profile.
- 2 Select **Settings > User List**. The User List page is displayed (see Figure 11).
- 3 Click **Add user**. The Add user dialog box displays.
- 4 Type the user's login and the user's password (see Figure 12).
- 5 Select the user's profile level. The following levels are available:
 - Admin (the user will be able to access all the features)
 - User (the user will only access the visualization and is not able to set changes to the system or nodes).
- 6 Click **Create new user**.

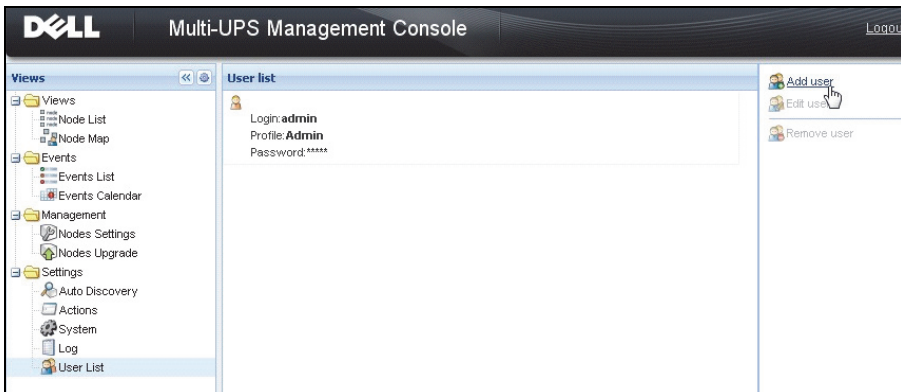

Figure 11. User List Page

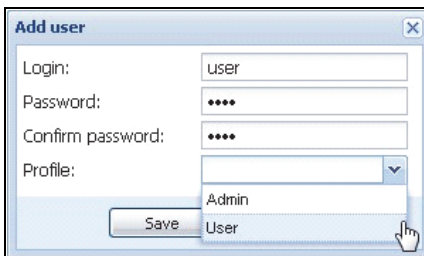

Figure 12. Add User Dialog Box

Note that the Dell MUMC contains a default Administrator profile with:

- “admin” as login
- “admin” as password

WARNING: For security reasons, it is strongly recommended that you change the default password immediately after the installation. A Popup provides a security warning if the password contains less than eight characters.

System Settings

You can edit system settings. From the **Settings > System** menu item, you can edit system information, edit language, edit scan settings, and edit module settings (see Figure 13).

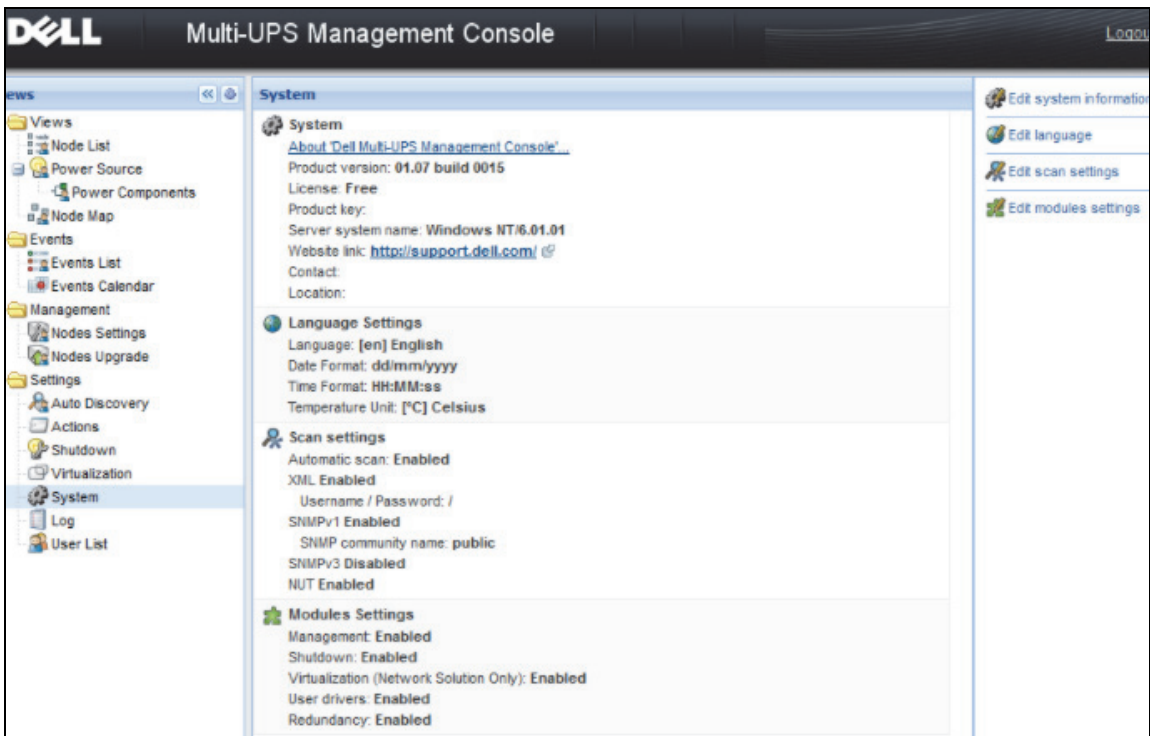

Figure 13. System Settings Page

Select one of the items, and then double-click the item, or single-click on the corresponding button in the right-hand side menu:

- Edit system information modifies contact and location information.
- Edit scan settings changes the default SNMP community name for discovery.

- **Edit modules** settings allows you to enable/disable Dell MUMC optional modules:
 - **Management** enables nodes settings mass configuration and nodes upgrade features
 - **Shutdown** enables shutdown of the computer running Dell MUMC in the event of a power failure
 - **Virtualization** enables management of virtualized IT systems
 - **Redundancy** provides support for >1 UPS in N+1 redundant configuration
- **Edit language** allows you to change the user language, the date and time format, and the temperature unit (Celsius or Fahrenheit)

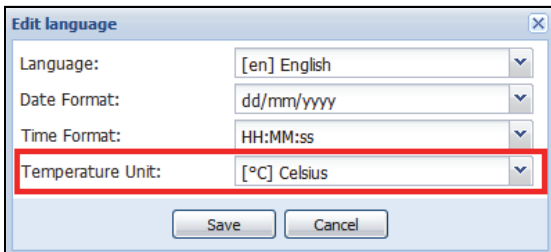

Figure 14. Edit Language Settings

Supervision

This chapter describes supervision features in the Dell Multi-UPS Management Console (MUMC).

Access to the Monitoring Interface

To monitor the Power Source, start the main Dell MUMC interface. You can access the interface locally or remotely.

Local Access

From the system where Dell MUMC is installed, you can use the following shortcut:

- **Start > Programs File > Dell > Multi-UPS Management Console > Open Dell Multi-UPS Management Console**

Remote Access

- 1 From a remote machine, you can type either of the following URLs in a Web browser:
https://<name or IP address of computer hosting Dell MUMC>:4680/
Or
http://<name or IP address of computer hosting Dell MUMC >:4679/
- 2 In SSL mode, accept the certificate by clicking **Yes** (see Figure 15).



Figure 15. Accepting the SSL Certificate

- 3** To install the certificate on IE7 for Vista, perform the following steps:
 - a** Run IE as an administrator by right-clicking the desktop icon and choosing “Run as Administrator.”
 - b** Open the Dell MUMC.
 - c** Click through the certificate error.
 - d** Click the **Certificate Error** button in the address bar.
 - e** Click **View Certificate**.
 - f** Click **Install Certificate**.
- 4** Click the “Place all certificates in the following store” radio button, and choose the “Trusted Root Certification Authorities” store. If you don't do this, the certificate goes in your personal store, and it is not trusted by IE.
- 5** Enter the Login and Password.

Node List View

The following default columns are displayed in this page (see Figure 16):

- **Type:** Graphical icon to differentiate UPS/PDU and Applications
- **Status:** This icon represents the severity of the most critical event active on the monitored device
- **Name:** The IP address, the DNS name or user defined name
- **Description:** The product name or description
- **Location:** The node location
- **Contact:** The node contact
- **Link:** Link to the device Web site (if available)

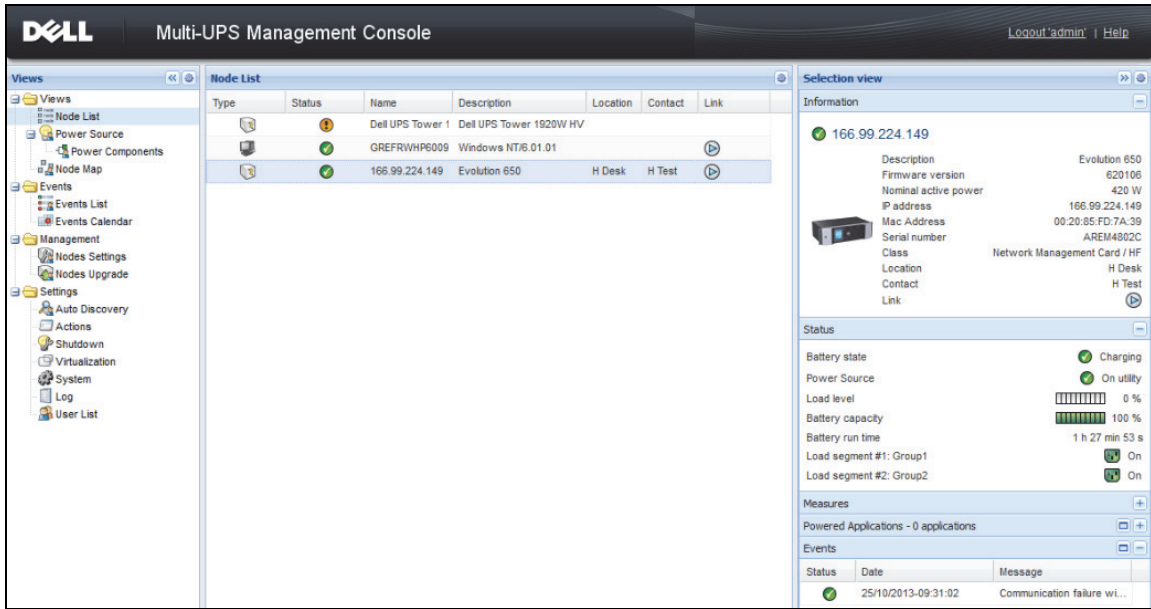

Figure 16. Node List View

You can sort (ascending or descending) your device list by clicking the column titles (Status / Name / Description / Location / Load Level ...). You can also add columns, as illustrated in Figure 17.

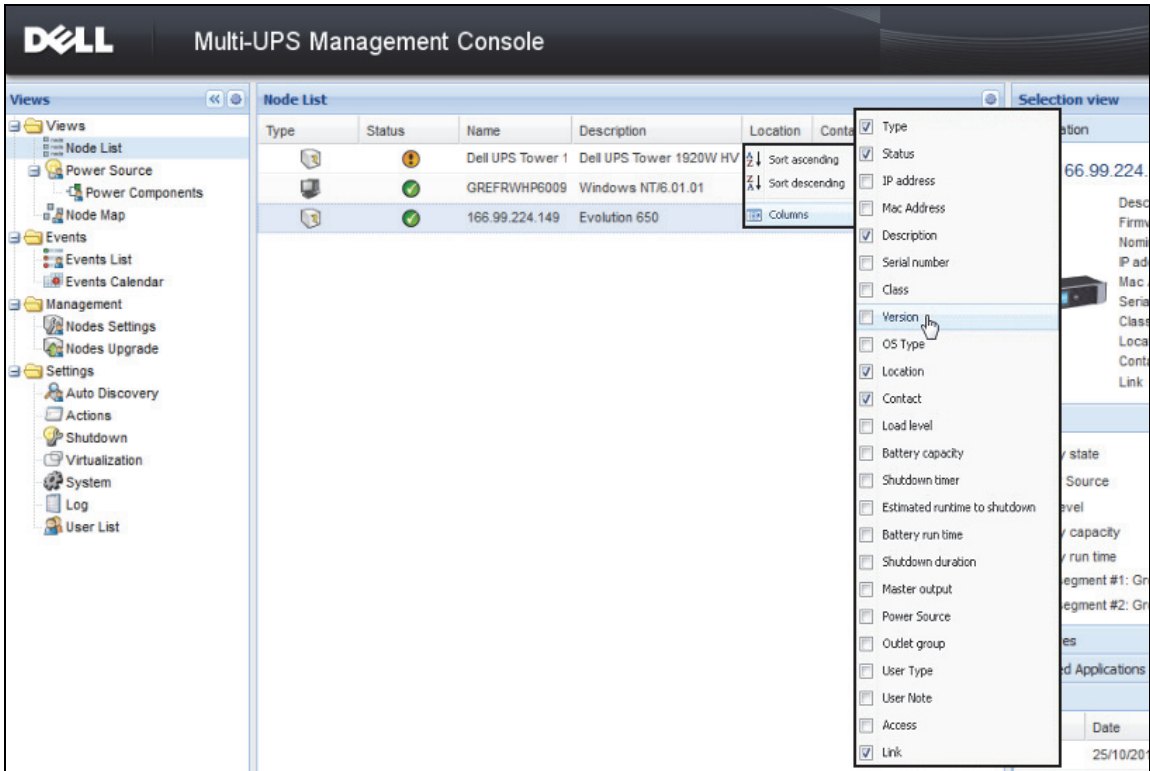

Figure 17. Adding Columns in Node List View

Flexible Panels View

The **Views >Power Source** menu item selection displays the Power Source page. You can select which information and status panels you want to see in the Power Source display for devices and applications in the Node List. For example, in Figure 18 the following panels display:

- Information and Status
- Measures
- Graph
- Synoptic

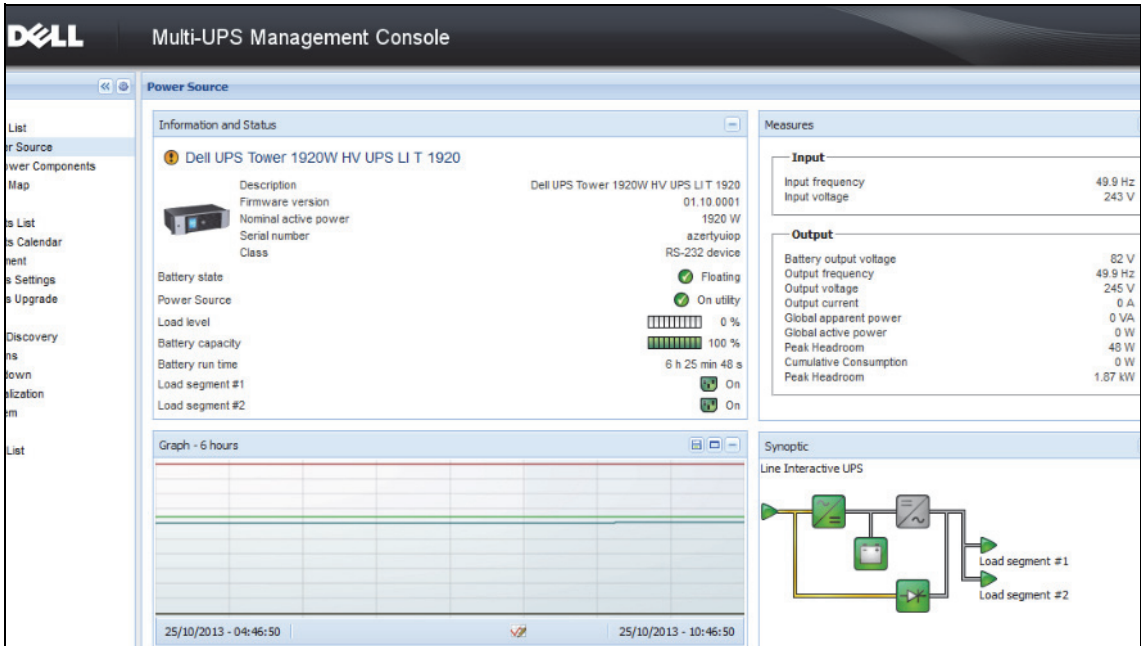



Figure 18. Power Source View

To select which panels display in the view, select one of the device/applications in the list and “Detailed Panels” displays in the right side of the window (see Figure 19).

- Click the bar title to collapse/extend the panel.
- You can also show  or hide  all the views menu or selection view menu.
- Select (check) a checkbox to select which panels you want to add in the selection view.

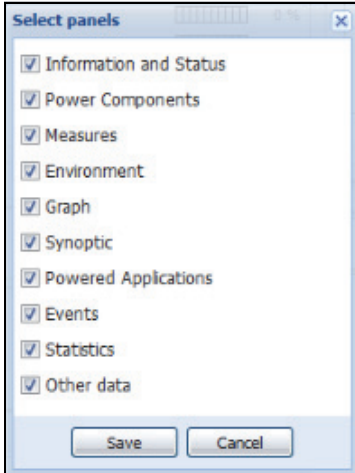

Figure 19. Panel Selection Dialog Box

NOTE: Some of the panels are only available for specific node types.

Panels List

Information Panel

The following node information is displayed in this panel (see Figure 20):

- 166.99.xx.yy: DNS name (or IP address) is displayed near the “status icon”
- **Description:** Commercial product name
- **Firmware version:** Firmware revision level of the UPS or the Dell NMC card setup as power source
- **Nominal Apparent Power:** Device load capacity in VA
- **IP address:** Device IP address
- **Mac address:** Device MAC address
- **Serial Number:** Device serial number (if available)
- **Class:** Type of card
- **Location:** Device location (value of syslocation object can also be configured in the Device page)
- **Contact:** Device contact (value of syscontact object can also be configured in the Device page)
- **Link:** Link to device Web site (if available)

NOTE: The information displayed in this panel depends on the node types you are viewing.

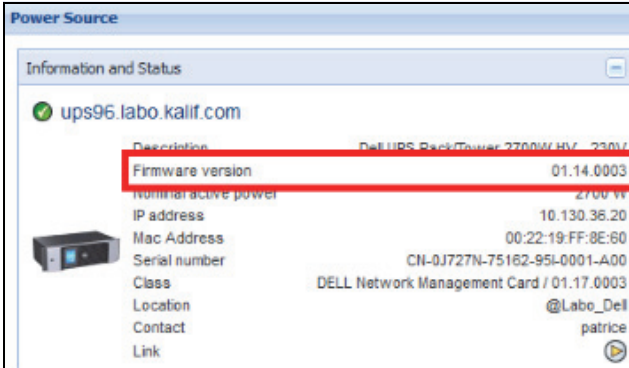

Figure 20. Information Panel

Status Panel

The following node status is displayed in this panel (see Figure 21):

- **Power source:** AC Power / Battery
- **Battery state:** Charging / Discharging / Default / Floating / Resting
- **Load Level:** Output load level of the device
- **Battery capacity:** Battery capacity of the device
- **Battery run time:** Thee device remaining backup time
- **Master Output:** Main output status (ON/OFF/Internal Failure/On Automatic Bypass/Manual ByPass/Overload)
- **Outlet #x:** Output outlet status (ON/OFF)

NOTE: The information displayed in this panel depends on the UPS capabilities.

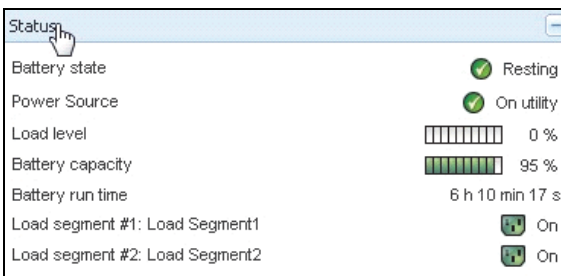



Figure 21. Status Panel

Outlets Panel

The following outlets status information is displayed for the selected PDU in this panel (see Figure 22):

- Contextual information is provided when mouse is over the outlet
- When you select an outlet in this panel, the Graph panel displays the information for this outlet.
- You also have to select Outlet information in the Graph settings dialog (accessible through the graph settings button  in the Graph panel)

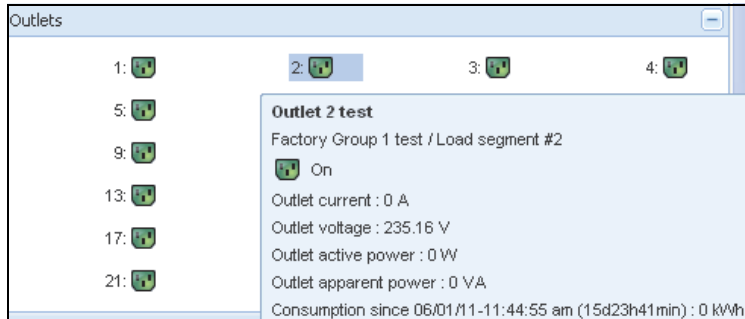



Figure 22. Outlet Panel

The outlet state is color coded in the display (see Table 7).

Table 7. Outlet Color Codes

Icon	Color	Description
	Green	Powered (ON)
	Red	Not powered (OFF)

Measures Panel

This panel displays the selected device electrical parameters for single-phase or three-phase devices, depending on the node capabilities (see Figure 23 and Figure 24).

Measures	
Input	
Input frequency	50 Hz
Input voltage	241 V
Output	
Battery output voltage	76 V
Output frequency	50 Hz
Output voltage	243 V
Output current	0 A
Global apparent power	0 VA
Global active power	0 W
Peak Consumption	12 W
Cumulative Consumption	0 W
Peak Headroom	1.91 kW

Figure 23. Measures Panel (Single Phase)

Measures			
Input			
	Phase 1	Phase 2	Phase 3
Input current	0 A	0.22 A	0 A
Input voltage	239.1 V	241.44 V	241.26 V
Input active power	0 W	21 W	0 W
Input apparent power	0 VA	49 VA	0 VA
Input frequency			49.9 Hz
Output			
Global apparent power			49 VA
Global active power			20 W
Consumption			
Phase 1 - since 06/06/11-7:04:55 pm			0.78 kWh
Phase 2 - since 06/06/11-7:05:22 pm			7.02 kWh
Phase 3 - since 06/06/11-7:05:48 pm			1.41 kWh
Global - since 01/01/00-1:04:03 am			12.17 kWh

Figure 24. Measures Panel (Three Phase)

Environment Panel

This panel displays the selected device sensor information (see Figure 25):

- **Temperature:** Temperature (in °C)
- **Humidity:** Humidity level
- **Input #1:** Status of first contact (open / closed)
- **Input #2:** Status of second contact (open / closed)

NOTE: For more information about the two optional input connections, please refer to the Dell Environmental Monitoring Probe (EMP) User Guide.

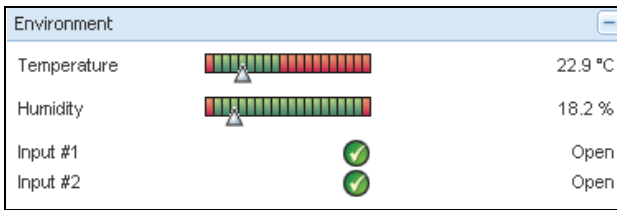

Figure 25. Environment Panel

Graph Panel

This panel displays the graph of the main measures of the selected device (see Figure 26):



- The  button allows you to zoom in the graph.
- The  button allows you to select the data you want to display in the graph.



Figure 26. Graph Panel

Synoptic Panel

This panel displays the selected device synoptic (see Figure 27). In the top left corner under the banner, the UPS electrical topology is indicated, such as Online UPS, Line Interactive UPS, and so forth. A tool tip is displayed when you move the mouse over one of the functional blocks.

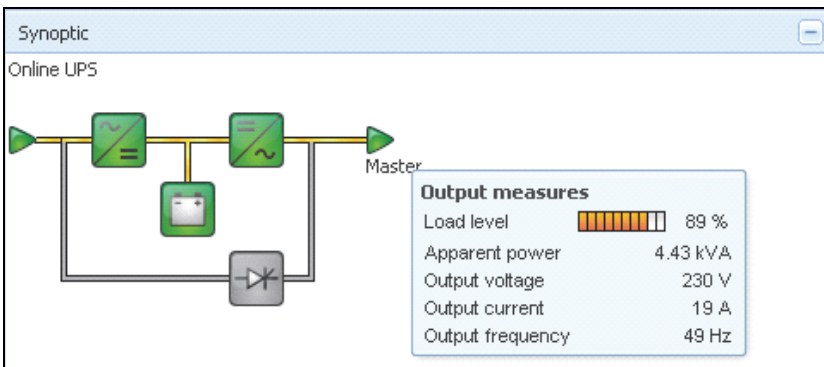

Figure 27. Synoptic Panel

The Synoptic color coded icons display for the following (see Table 8):

- UPS modules
- Battery modules
- Electrical flows
- Electrical power sources at UPS input
- Load at UPS output, with status linked to UPS output status
- Combined color codes

Table 8. Synoptic Panel Icons



















Symbol	Color	Description
UPS Modules		
AC/DC DC/AC Bypass 	Green	Status OK and Active
AC/DC DC/AC Bypass 	Red	Internal Fault and Inactive
AC/DC DC/AC Bypass 	Gray	Status OK and Inactive or Unknown
Battery Modules		
	Green	Status OK
	Orange	Battery charge is less than 50%
	Red	Battery fault or End-of-backup
	Gray	Battery status unknown
Electrical Flows		

Table 8. Synoptic Panel Icons (Continued)

Symbol	Color	Description
	Yellow	Current flow through the cable NOTE: The object animation gives the direction of the current flow.
	Gray	No current flow through the cable WARNING: The cable may be under voltage.
Electrical Power Source at UPS Input		
	Green	Source powered. Status OK
	Gray	Source not powered or status unknown
Load at UPS Output		
	Green	Load powered and protected. Status OK
	Red	Load not powered
	Gray	Load status not known
Combined Color Code: Flow and Power Source Status		
	Green/Yellow	Electrical power source is powered and provides electrical flow
	Green/Gray	Electrical power source is powered and does not provide electrical flow
Combined Color Code: Flow and Load Status		
	Yellow/Green	Load powered and protected
	Gray/Red	Load not powered

Power Source

The Power Source panel displays information on the device that powers the selected application running on the server (see Figure 28).

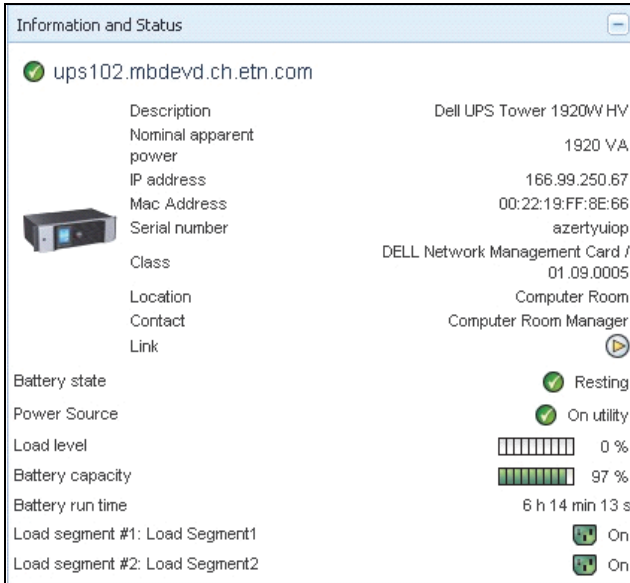

Figure 28. Power Source

Powered Applications

The Powered Applications panel displays information on the applications, such as the Dell UPS Local Node Manager (ULNM), that are powered by the selected device (other Dell ULNM) and their shutdown timing profile following a power failure event (see Figure 29).

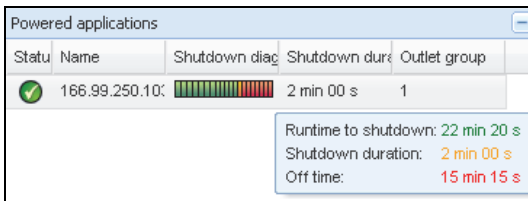
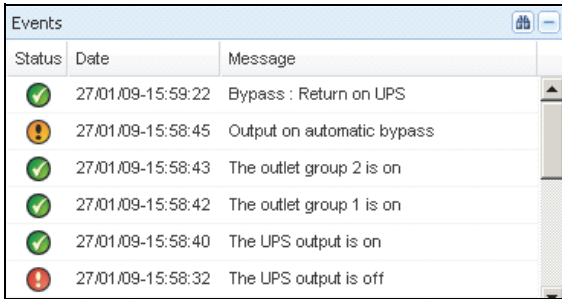

Figure 29. Powered Applications

Events Panel

This panel displays the events list of the selected node (see Figure 30). You can sort the events according to status, date, and message by clicking the column header.



Status	Date	Message
✓	27/01/09-15:59:22	Bypass : Return on UPS
⚠	27/01/09-15:58:45	Output on automatic bypass
✓	27/01/09-15:58:43	The outlet group 2 is on
✓	27/01/09-15:58:42	The outlet group 1 is on
✓	27/01/09-15:58:40	The UPS output is on
⚠	27/01/09-15:58:32	The UPS output is off

Figure 30. Events Panel

Statistics Panel

This panel displays the statistics of the selected node (see Figure 31). The  button allows you to select the time interval for the statistics. You can adjust the time interval by clicking the two buttons with the “From” and “To” dates.

The statistics computed data is as follows:

- Apparent Consumption (or Active Consumption in next release, in Watts)
- Average Apparent Power (or Average Active Power in next release, in Watts)
- Power Failure Count
- Power Failure Cumulated Duration
- Battery Fault Count
- Internal Failure Count
- Overload Count
- Warning Alarm Count
- Critical Alarm Count
- Output Off Count
- Communication Lost Count

NOTE: This information depends on device capabilities.

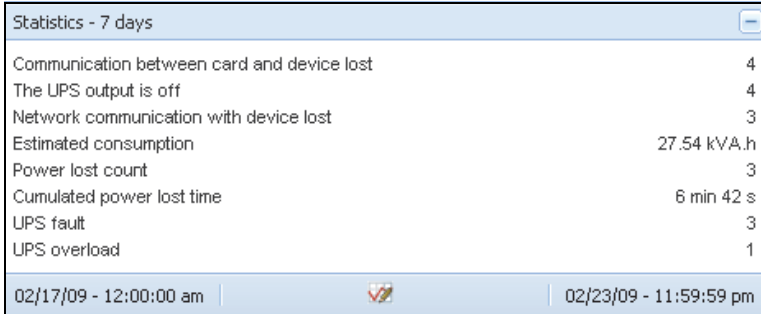

Figure 31. Statistics Panel

Power Components

Figure 32 illustrates the Power Components View. This panel displays the components of your redundant UPS system if the Redundancy feature is activated (see Chapter 8, “Redundancy” on page 99).

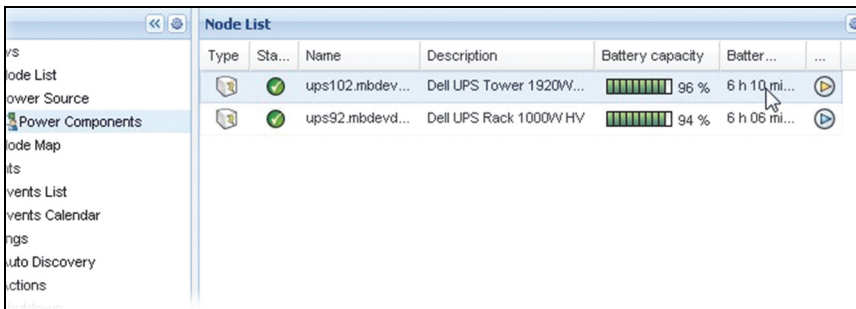

Figure 32. Power Component View (Sub-view of Power Source View)

Device Supervision

The bar at the bottom of the page provides the status of nodes being supervised. Note the following in Figure 33:

- 14 nodes are OK
- 4 nodes are in Warning status
- 2 nodes are in Critical status
- 0 nodes are in Unknown status



Figure 33. Bottom Bar for Device Supervision

Applications List View

To create a sub-view that filters applications, right click Node List, create a sub-view, then select Category as criteria to filter the nodes (see Figure 34 and Figure 35). You can create sub-views from the following information: Category, Contact, Description, IP address, Location, Name, Status, Type, User Note, User Type. The Dell ULNM running on other computers in the network can be monitored in this view.

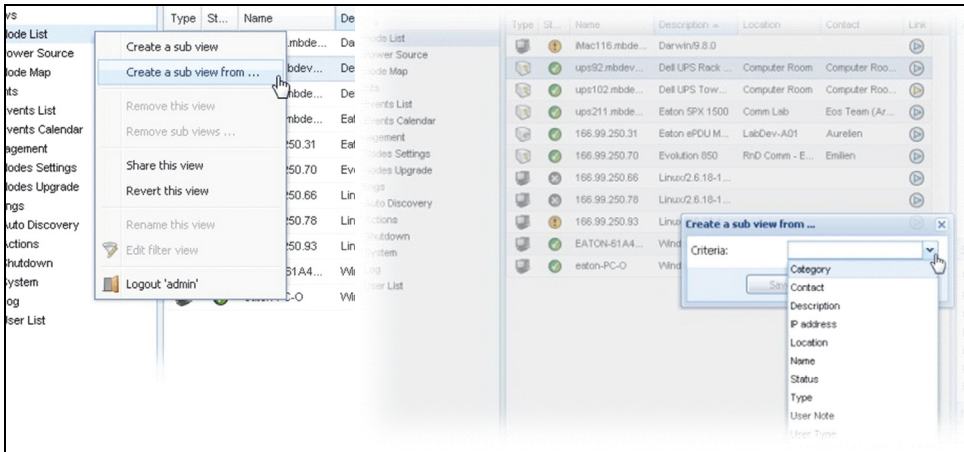

Figure 34. Sub-view Selections

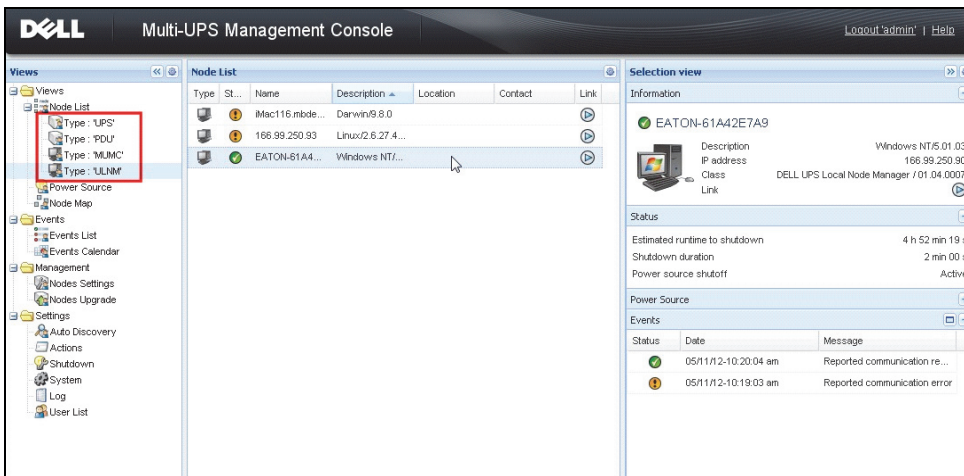

Figure 35. Example Sub-view

The following default information appears in this page:

- **Type:** Application
- **Status:** This icon represents the status of the server.
- **Name:** Value configured in the Applications screen (by default this is an IP address or a DNS name).
- **Description:** Machine operating system.
- **Power source:** The UPS that powers the Dell ULNM application/computer
- **Run time:** Operating time in the event of a utility supply loss.
- **Shutdown duration:** Duration in seconds, needed by the system to carry out its shutdown procedure.
- **Link:** Link to the Web supervision interface of the Dell ULNM

Map View

This supervision map allows you to spatially represent your network nodes and uses “drag and drop” functionality.

NOTE: Clicking a node icon will present the node information on the right-hand panel.

Create a Customized Map View

The customized map view is accessed on the left-side menu using the **Views > Node Map** selection. The map is automatically generated. (Icons are automatically placed on the Map and IP address assigned.)

The contextual tool button  on the Node Map title bar provides tools to modify the map (see Figure 36):

- Change theme offers three kinds of icons representations (small tower icons, large tower icons, and large rack icons).
- Manage backgrounds allows you to import a new background image in the supervision tool (png, jpeg, and gif picture types supported). You can select a background already in the supervision tool for the map or remove the background images.
- Regroup nodes will rearrange the icons position on the Map.
- “Add a label” allows to create a user defined text and to place it on the Map through drag and drop.

NOTE: To delete a label, right-click on it and then click **Delete**.

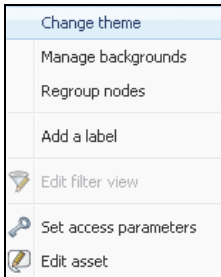

Figure 36. Contextual Tools Menu

Map Examples

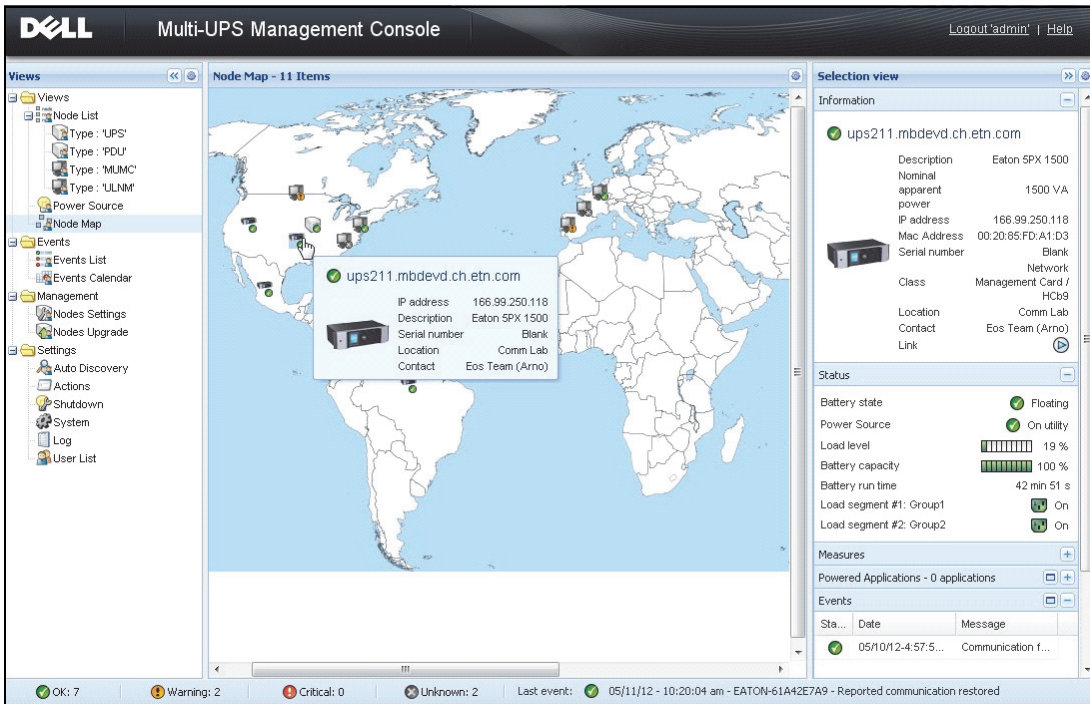

Figure 37. World Map View

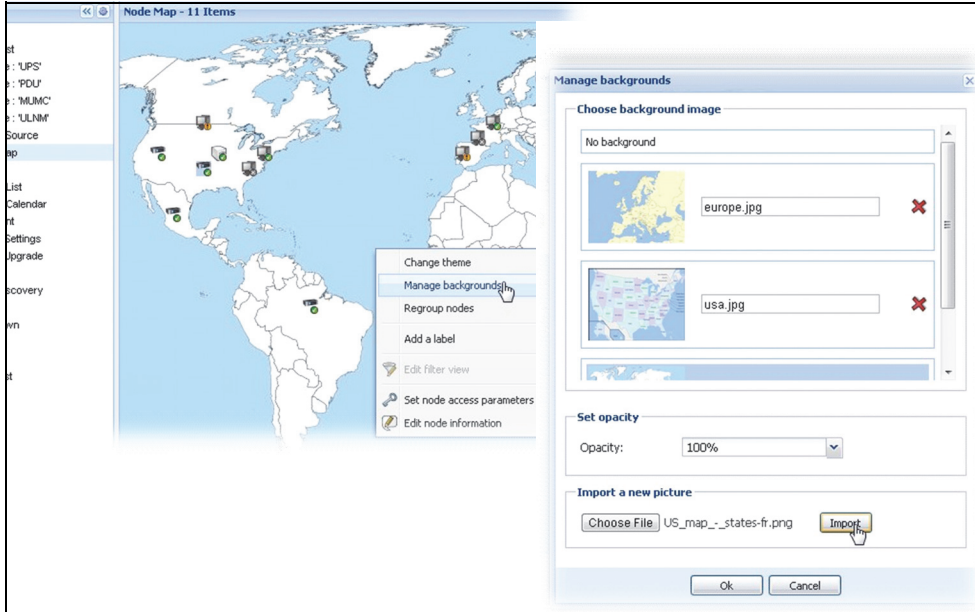

Figure 38. Manage Backgrounds Contextual Menu



Figure 39. Country Map View

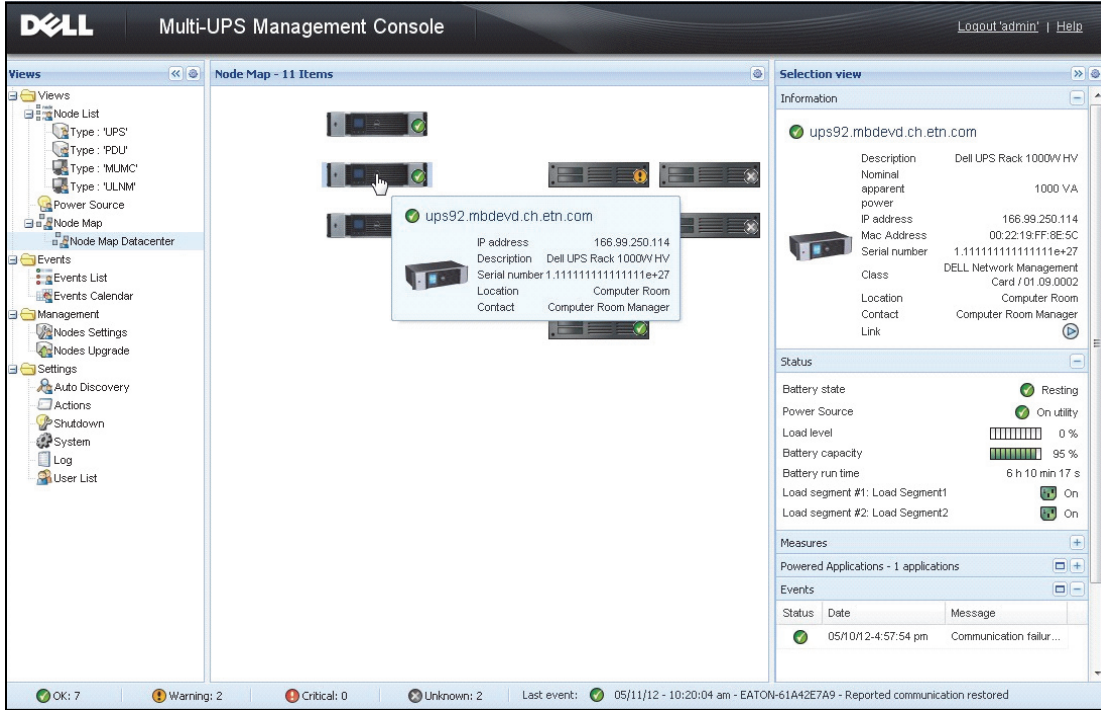
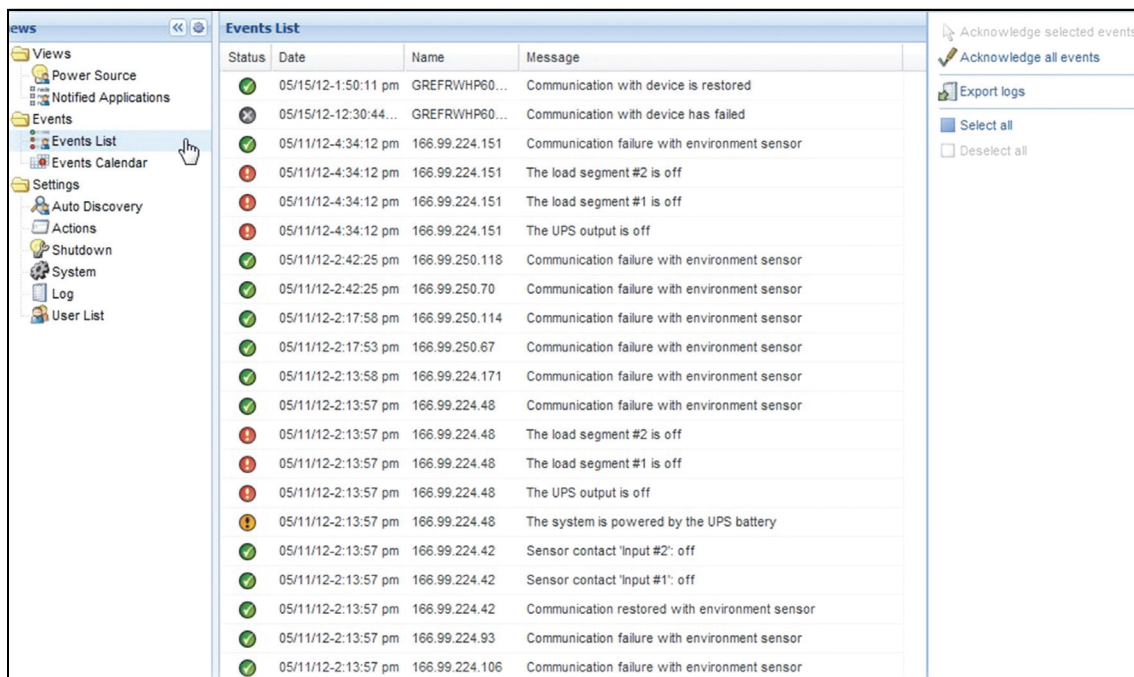

Figure 40. Server Room Map View

Events

List Representation

Select **Events > Events List** to display the Events List page (see Figure 41). All new alarms are stored in this log. You can sort the alarms according to the Status, Date, Name, Message, and Ack fields.



Status	Date	Name	Message
✓	05/15/12-1:50:11 pm	GREFRWHP60...	Communication with device is restored
✗	05/15/12-12:30:44...	GREFRWHP60...	Communication with device has failed
✓	05/11/12-4:34:12 pm	166.99.224.151	Communication failure with environment sensor
!	05/11/12-4:34:12 pm	166.99.224.151	The load segment #2 is off
!	05/11/12-4:34:12 pm	166.99.224.151	The load segment #1 is off
!	05/11/12-4:34:12 pm	166.99.224.151	The UPS output is off
✓	05/11/12-2:42:25 pm	166.99.250.118	Communication failure with environment sensor
✓	05/11/12-2:42:25 pm	166.99.250.70	Communication failure with environment sensor
✓	05/11/12-2:17:58 pm	166.99.250.114	Communication failure with environment sensor
✓	05/11/12-2:17:53 pm	166.99.250.67	Communication failure with environment sensor
✓	05/11/12-2:13:58 pm	166.99.224.171	Communication failure with environment sensor
✓	05/11/12-2:13:57 pm	166.99.224.48	Communication failure with environment sensor
!	05/11/12-2:13:57 pm	166.99.224.48	The load segment #2 is off
!	05/11/12-2:13:57 pm	166.99.224.48	The load segment #1 is off
!	05/11/12-2:13:57 pm	166.99.224.48	The UPS output is off
!	05/11/12-2:13:57 pm	166.99.224.48	The system is powered by the UPS battery
✓	05/11/12-2:13:57 pm	166.99.224.42	Sensor contact 'input #2': off
✓	05/11/12-2:13:57 pm	166.99.224.42	Sensor contact 'input #1': off
✓	05/11/12-2:13:57 pm	166.99.224.42	Communication restored with environment sensor
✓	05/11/12-2:13:57 pm	166.99.224.93	Communication failure with environment sensor
✓	05/11/12-2:13:57 pm	166.99.224.106	Communication failure with environment sensor

Figure 41. Events List Page

The following functions are available:

- **Acknowledge selected events:** Adds a check box in the Ack column for selected events
- **Acknowledge all events:** Adds a check box in the Ack column for all events

NOTE: When an alarm is acknowledged, it is marked with a check box but it is still viewable in this Event list. The acknowledged alarms disappear in the **Power Source > Event** dedicated portal panel.

- **Export Logs:** Creates a logs.csv file with the following syntax:

```
"Date", "Node", "Type", "Level", "Object", "Value", "Message",  
"2009/01/27-  
18:35:20.840", "166.99.250.83", "Measure", "0", "UPS.PowerConverter.Inpu  
t[1].Frequency", "49", "",
```

NOTE: The export command may take several seconds before allowing download to create the logs file.

- **Select all:** Selects all displayed events
- **Deselect all:** Deselects all selected events

Calendar Representation

Select **Events > Events Calendar** to display the Events Calendar page (see Figure 42). In this matrix representation, each line is a week and each column is a day in the week. If you select a day or an interval (with the date-picker or using the shift+click command), the Events and Statistics panels provide all information for this selection and automatically refresh when new statistics have been computed.

The screenshot displays the Dell Multi-UPS Management Console interface. The top navigation bar shows the Dell logo, the title "Multi-UPS Management Console", and a "Logout 'admin'" link. The left sidebar contains a "Views" tree with categories like Views, Events, Management, and Settings. The main area is divided into three panels: "Events Calendar", "Selection view", and a status bar at the bottom.

The "Events Calendar" panel shows a weekly grid for the week of May 11, 2012. A date picker is overlaid on the calendar, showing the date "May 11, 2012" and counts for events: 4 Warning (yellow exclamation mark) and 2 Unknown (grey X) events.

The "Selection view" panel displays a table of events for the selected date:

Status	Date	Name	Message
✓	05/11/12-10:...	EATON-61A...	Reported communication...
✓	05/11/12-10:...	EATON-61A...	Reported communication...
✓	05/11/12-10:...	eaton-PC-O	Reported communication...
!	05/11/12-10:...	iMac116.mb...	Reported communication...
!	05/11/12-10:...	166.99.250.93	Reported communication...
✓	05/11/12-10:...	166.99.250.93	Reported communication...
!	05/11/12-10:...	eaton-PC-O	Reported communication...
✗	05/11/12-9:3...	166.99.250.78	Communication with devi...
✗	05/11/12-8:5...	166.99.250.66	Communication with devi...

At the bottom of the interface, a status bar shows overall system health: OK: 7, Warning: 2, Critical: 0, Unknown: 2. The "Last event" is listed as "05/11/12 - 10:20:04 am - EATON-61A42E7A9 - Reported communication r".

Figure 42. Event Calendar Page

Nodes Events List

The icons in the different views represent the event severity.

 **NORMAL** With this event, the UPS device is returning to a normal status.

Normal Event list (UPSs, PDUs, Applications, Generic devices):

- Communication with device is restored
- Communication restored with UPS
- The system is powered by the utility
- The UPS output is on
- Communication restored with UPS
- Battery OK
- UPS returns to normal load
- UPS OK
- Bypass: Return on UPS
- End of low battery alarm
- The outlet group 1 is on
- The outlet group 2 is on
- Communication failure with environment sensor
- Communication restored with environment sensor
- Humidity is in normal range
- Temperature is in normal range
- Input #x on
- Input #x off
- End of warning alarm
- End of critical alarm
- Redundancy restored
- Protection restored

PDU Normal Event List (Specific to PDUs):

- The input frequency is in normal range
- The input temperature is in normal range
- The input voltage is in normal range
- The input {x} is in normal load
- The section {x} current is in normal range

- The section {x} voltage is in normal range
- The outlet group {x} current is in normal range
- The outlet group {x} is in normal load
- The outlet group {x} is on
- The phase {x} output load is in normal range
- The output frequency is in normal range
- The output load is in normal range
- The output voltage is in normal range

 **WARNING** A problem occurred on the UPS device. Your application is still protected.

Warning Event List (UPSs, PDUs, Applications, Generic devices):

- The system is powered by the UPS battery
- Output on automatic bypass
- Output on manual bypass
- Humidity is below low threshold
- Humidity is above high threshold
- Temperature is below low threshold
- Temperature is above high threshold
- Warning Alarm (a generic Warning alarm is active on the device)
- The device is under its load alarm threshold
- The device is over its load alarm threshold
- Protection lost
- Redundancy lost
- Shutdown in <time>
- Remote Communication Error (remote communication or configuration issue is detected)



CRITICAL A serious problem occurred on the UPS device. This problem requires an urgent action. Your application might NOT BE powered.

Critical Event List (UPSs, PDUs, Applications, Generic devices):

- The UPS output is off
- The outlet group 1 is off
- The outlet group 2 is off
- Battery fault
- UPS overload
- UPS fault
- Low battery alarm
- Applications must stop immediately...
- System shutdown in progress...
- Critical alarm (a generic Critical alarm is active on the device)

PDU Critical Event List (Specific to PDUs):

- The input frequency is out of range
- The input temperature is above high threshold
- The input temperature is below low threshold
- The input voltage is above high threshold
- The input voltage is below low threshold
- The input {x} is overload
- The section {x} current is too high
- The section {x} current is too low
- The section {x} voltage is too high
- The section {x} voltage is too low
- The outlet group {x} current is too high
- The outlet group {x} current is too low
- The outlet group {x} is overload
- The outlet group {x} is off
- The phase {x} output is overload
- The output frequency is out of range
- The output is overload
- The output voltage is above high threshold
- The output voltage is below low threshold

 **COMMUNICATION LOST** Communication is lost.



Communication Lost Event List:

- Communication failure with Device or Application

 **DEVICE IS NOT MANAGED** Device is not managed

- Your device is not managed due to license limitation. Use the **Settings > System** selection to enter a Silver or Gold license code.

Launching Device Web Interface

From the Status panel, you can access the Web page for Dell cards, including an on-board Web server. Click the associated Web link for http access (blue icon ) or the https access (yellow icon )

Defining Sub-views

When you need to monitor large configurations, it is helpful to define several sub-views and then filter the nodes or events in these categories. You can select many criteria in order to organize your tree, such as geographical, organizational, by status, and so forth.

To define a sub-view:

- 1 Select a view in the **Views > Node** list, such as “Category: Devices” (see Figure 43).
- 2 Right-click this selection. The contextual menu sub-views displays (see Figure 44).
- 3 Click **Create a sub-view from ...** and follow the instructions.

To filter the nodes in this sub-view,

- 1 Select a view in the **Views > Node** list, such as “Location: Computer Room” (see Figure 43).
- 2 Right-click this selection. The contextual menu sub-views displays (see Figure 44).
- 3 Click **Edit a Filter View**. The View Filter Rules dialog box displays (see Figure 45).
- 4 Click **Add rule**, then key in the Object, Operation and Values.

NOTE: With the setup shown in Figure 45, this filtered view will allow you to view the devices whose Location field contains the value “Computer Room.”

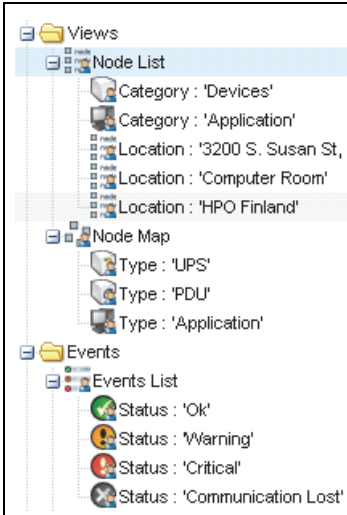

Figure 43. Views > Node List Example Hierarchy

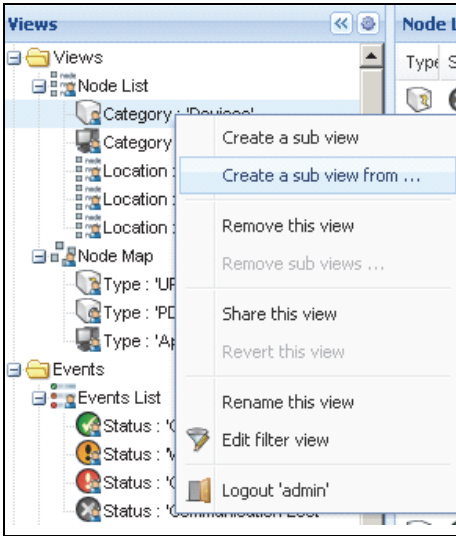

Figure 44. Contextual Sub-view Menu

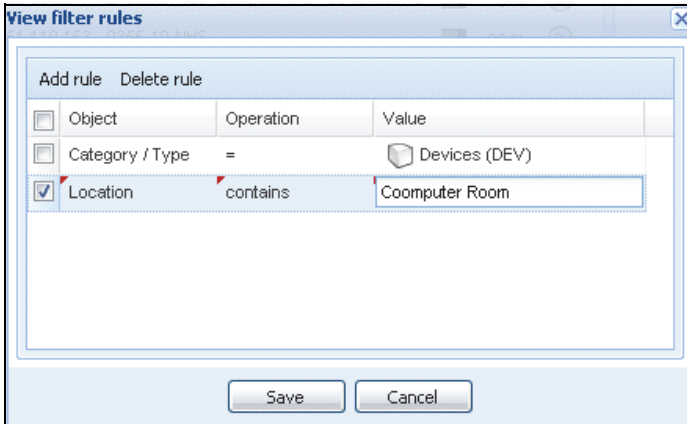

Figure 45. View Filter Rules Dialog Box

Sharing Sub-views

A customized sub-view is “attached” to the user that created it. It is private. The customized sub-view is marked with a small man on the icon of the sub-view (see Figure 46).

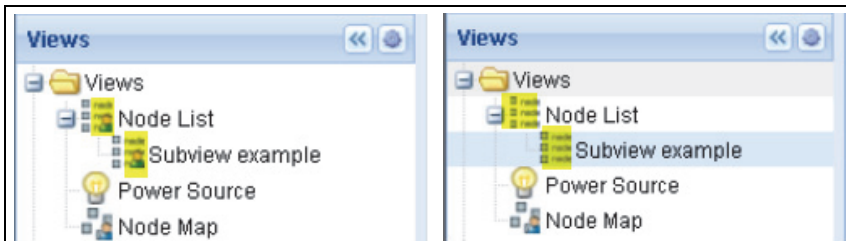

Figure 46. Shared View with Marker (left) and Public View without Marker (right)

If the owner of the sub-view wants to allow the use of the sub-view by the other users, he needs to share the view.

To share the view:

- 1 Right-click the view to open the contextual menu (see Figure 47).

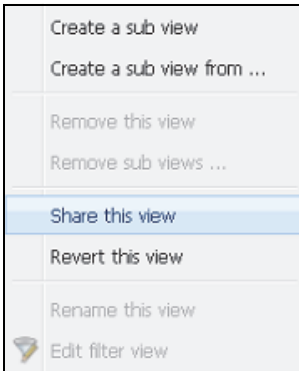

Figure 47. Contextual Sub-view Menu

2 Click **Share this view** (see Figure 48).

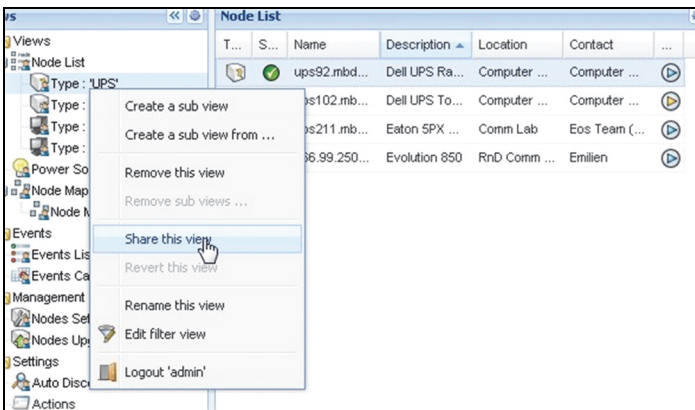

Figure 48. Share the View Selection

NOTE: Customizing a view cancels the sharing of this view. For the use of this view by all the users, the owner of the view must share it again.

Shutdown

The Dell Multi-UPS Management Console (MUMC) provides local computer graceful shutdown (when connected to a UPS through either Dell Network Management Card, USB or RS-232)

This shutdown feature can be enabled or disabled from the **Settings > System > Modules Settings** selection path.

Shutdown Configuration

To access the shutdown configuration options:

- 1 Login with an administrator user profile.
- 2 Select **Settings > Shutdown**. The Shutdown page is displayed (see Figure 49).

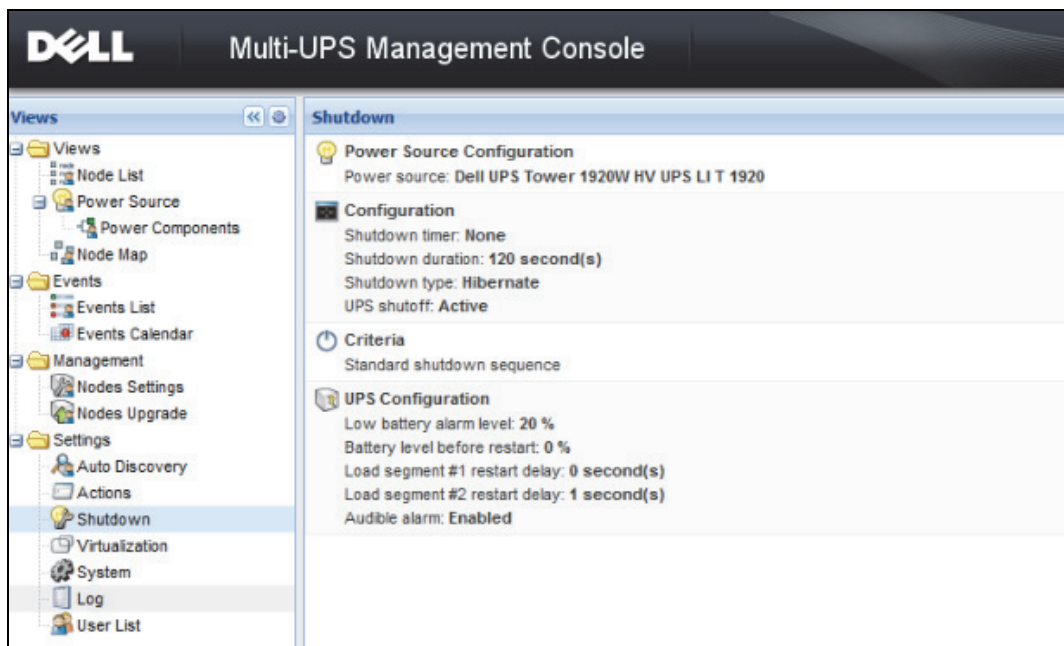

Figure 49. Shutdown Page

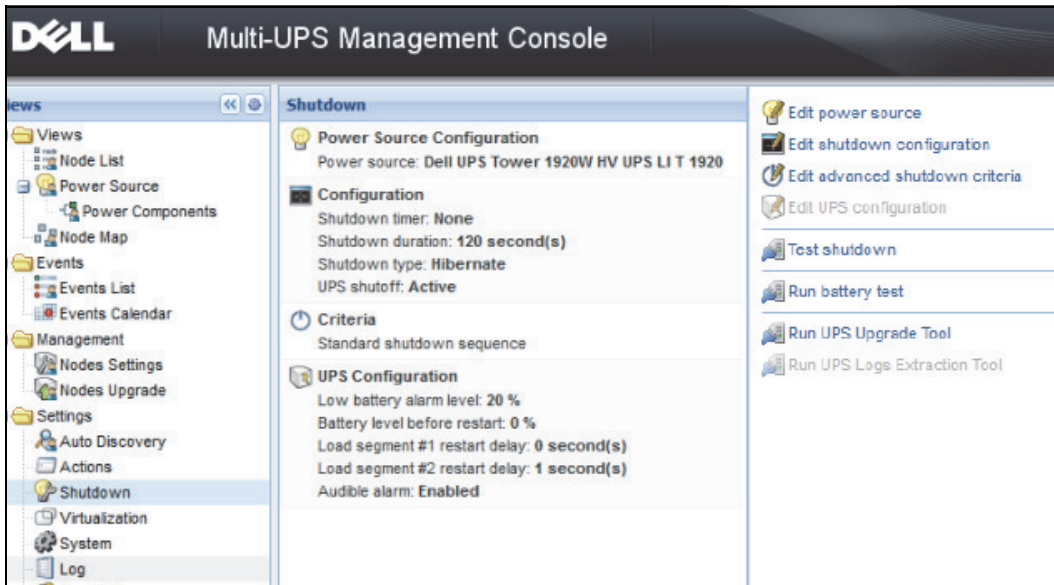

Figure 50. Configuration Buttons in Right-side Panel

The following configuration buttons are provided on the right-side panel (see Figure 50):

- Edit power source
- Edit shutdown configuration
- Edit advanced shutdown criteria
- Edit UPS configuration
- Test shutdown (see Figure 51)
- Run battery test: Launch a battery test if the following conditions are true :
 - Battery must be in rest mode.
 - The load must be over 25%.
- Run UPS Upgrade Tool: Use if the following conditions are true :
 - A power source has been set up in the software.
 - The Dell UPS Upgrade tool is installed on the operating system.

- Run UPS Logs Extraction Tool if the following conditions are true:
 - A power source has been set up in the software.
 - The Dell UPS Logs Extraction Tool is installed on the operating system.
 - Communication with UPS through Serial connection.
 - It is installed on a Windows Operating System in the list of supported OS.

NOTE: Note: If the Dell UPS is connected through the USB or if the software is running on a Linux Operating System (not supported by the “Dell UPS Logs Extraction Tool,” the button will be disabled.

NOTE: Refer to the *Dell™ UPS Local Node Manager® Installation and Configuration User's Guide* for a detailed description of the Shutdown feature.

NOTE: For Test Shutdown, check the settings for the UPS shutoff option to ensure the expected behavior: with the “UPS shutoff” option enabled, the shutdown sequence test will lead to the full UPS shutdown (see Figure 51).

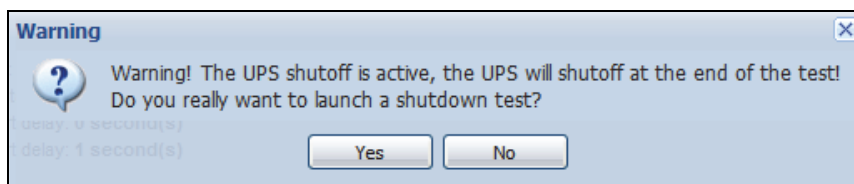

Figure 51. Test Shutdown Warning Message

Shutdown through Hibernate

If available with your operating system, it is better to use the hibernation feature (available from Microsoft® Windows® 2000 and later versions) because there are a number of advantages. When the computer is shutting down, all work in progress and system information are automatically saved to the disk. The computer itself is also de-energized. When mains power returns, all the applications re-open exactly as they were and the user placed back in their work environment.

The Hibernate function must first have been activated in the operating system in the power options on the Windows control panel Hibernate tab.

NOTE: If you select hibernate, but your computer does not have this function, the Dell MUMC will still protect the system by carrying out the normal (default) shutdown action.

Power Source View

When Shutdown feature is configured from the Views menu Item, select the Power Source item. You will be able to perform the following:

- To supervise the information from the UPS that powers the Dell MUMC computer.
- To drag and drop the panels in this window to different locations to suit your viewing preference.
- In the graph panel of power source view, several measurement data are displayed (see Figure 52.)

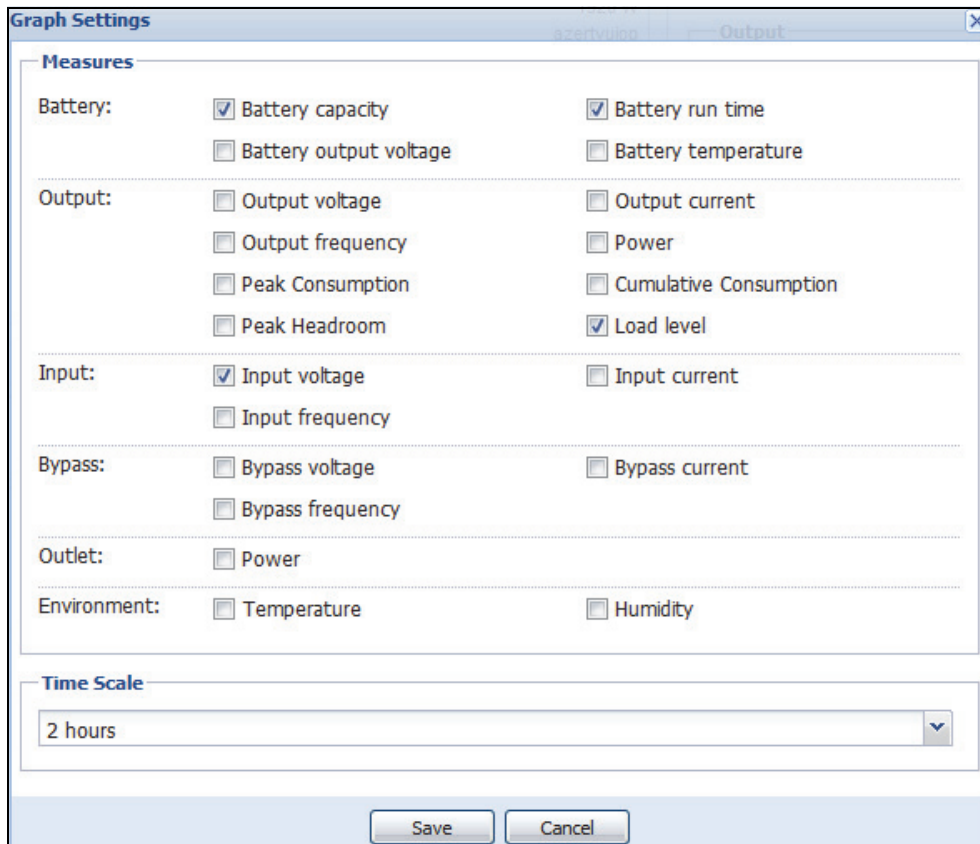



Figure 52. Graph Settings Dialog Box

- To export data shown in the graph panel using the export data  button (see Figure 53).
- To export data into a comma-separated value (CSV) file, use the Export logs button located in the Graph panel menu bar. The time scale chosen will apply to extracted logs.

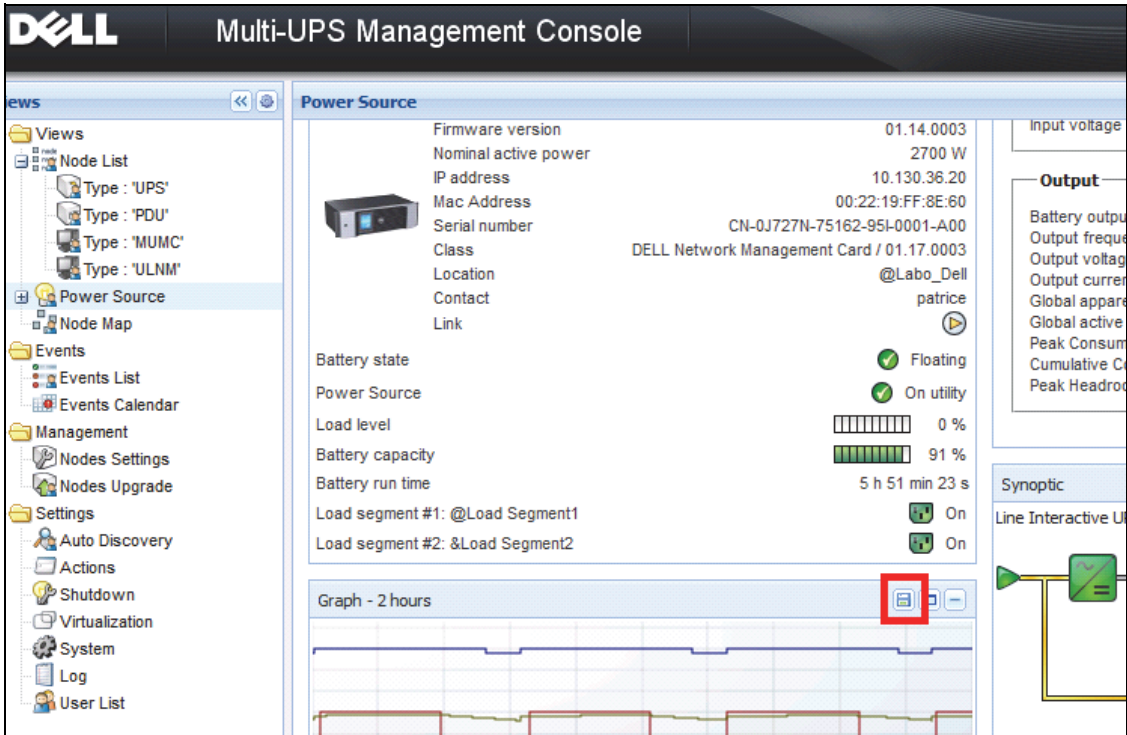

Figure 53. Export Graph Data Button in Graph Panel

Shutdown Sequence

You cannot enable the Shutdown Controller feature in Dell MUMC. However, the Dell MUMC can acquire shutdown alarms from Dell UPS Local Node Manager (ULNM) with the Shutdown Controller module enabled.

You will find more details on the Shutdown Sequence and Shutdown Use case in the *Dell™ UPS Local Node Manager® Installation and Configuration User's Guide*.

Advanced Management

Nodes Settings

Single Node Configuration Display

Dell Multi-UPS Management Console (MUMC) can display the card/application configuration for other nodes on the network. Proceed as follows:

- 1 From **Management > Nodes Settings**, select one node from the Node List page (see Figure 54).
- 2 After a few seconds, on the right hand, the Node configuration panel is updated.
- 3 If you wish to save a standard node configuration (for example to deploy to other similar nodes), use the **Configurations > Export Configuration** file to export this configuration to a file.

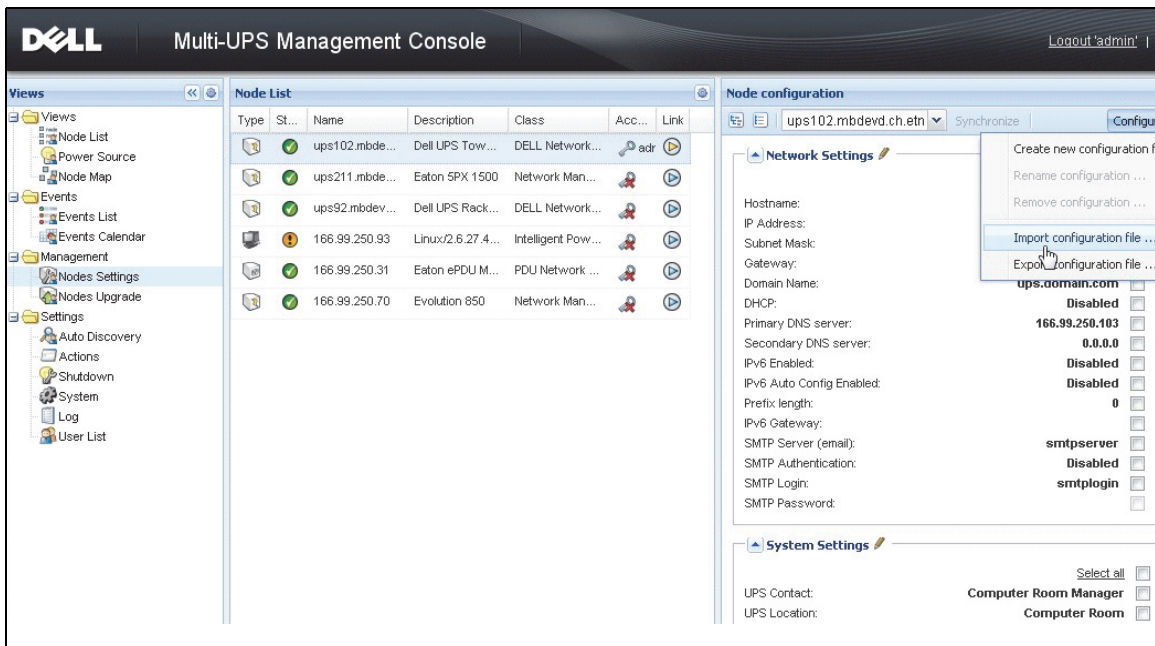





Figure 54. Nodes Settings View

Single Card Settings

Dell MUMC can configure a remote Dell Network Management Card.

Proceed as follows:

- 1 Login with an administrator profile.
- 2 Select one card from the list.
- 3 From the Node List button , select **Set Login Parameters**, enter the card Login and Password. The access status changes from Access Denied () to Access OK (). After a few seconds, the Node configuration panel is updated.
- 4 Click the Edit button , or load a previously saved configuration.
- 5 In the Network Settings Configuration dialog box, check the parameters you want to change and fill in the new values (see Figure 55).

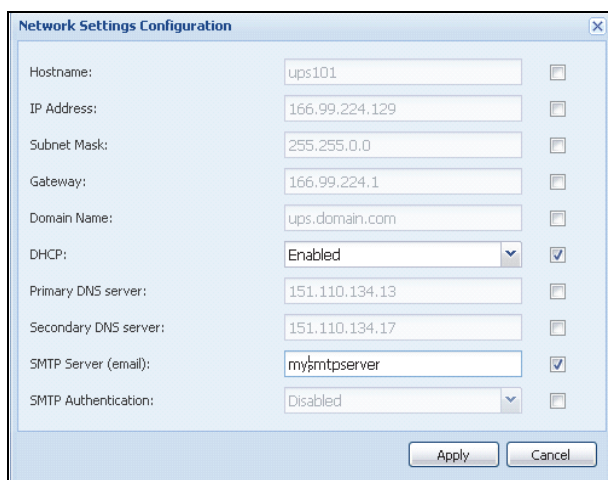

Hostname:	ups101	<input type="checkbox"/>
IP Address:	166.99.224.129	<input type="checkbox"/>
Subnet Mask:	255.255.0.0	<input type="checkbox"/>
Gateway:	166.99.224.1	<input type="checkbox"/>
Domain Name:	ups.domain.com	<input type="checkbox"/>
DHCP:	Enabled	<input checked="" type="checkbox"/>
Primary DNS server:	151.110.134.13	<input type="checkbox"/>
Secondary DNS server:	151.110.134.17	<input type="checkbox"/>
SMTP Server (email):	mysmtpserver	<input checked="" type="checkbox"/>
SMTP Authentication:	Disabled	<input type="checkbox"/>

Figure 55. Network Section

- 6 Apply the changes.
NOTE: The parameters that have different values on the cards and on the configuration to apply have the  sign.
- 7 Select the parameters you want to synchronize (with the check box).
- 8 Click **Synchronize**.

Some advanced parameters details are not displayed in the Network Settings Configuration dialog box. You need to change the advanced parameters details directly on one device and then synchronize the configuration from this device to other devices.

Figure 56 provides a typical example with PDU Power Schedule configuration. The details of Power Schedule 1 to Power Schedule 8 are available from the device Web interface. Checking all Power Schedule “n” advanced parameters will synchronize all the advanced parameters details of the category.

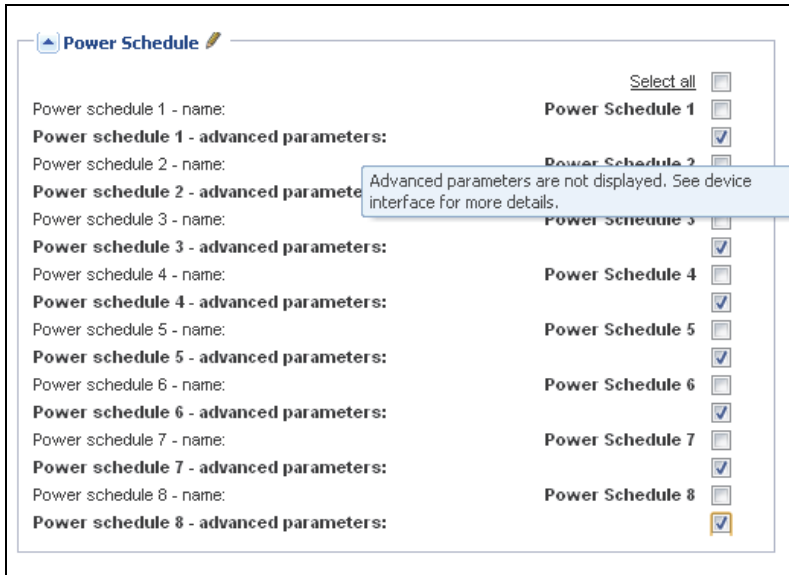





Figure 56. Advanced Parameters Not Displayed

Multiple Cards Configurations Synchronization

The Dell MUMC can make changes to multiple Dell Network Management Card configurations simultaneously.

Proceed as follows:

- 1 From **Management > Nodes Settings**, select several cards from the Node List page using a “ctrl-and-click” action (see Figure 57).
- 2 From the Node List button , select **Set Login Parameters** and enter the card login and password. The access status changes from: Access Denied () to Access OK (). After a few seconds, the Node configuration panel is updated.
- 3 From the combo box select the configuration that will be the model, or click **Edit** . The parameters that have different values on the cards have the \neq sign.
- 4 Select the parameters you want to synchronize (with the check box).
- 5 Click **Synchronize**.

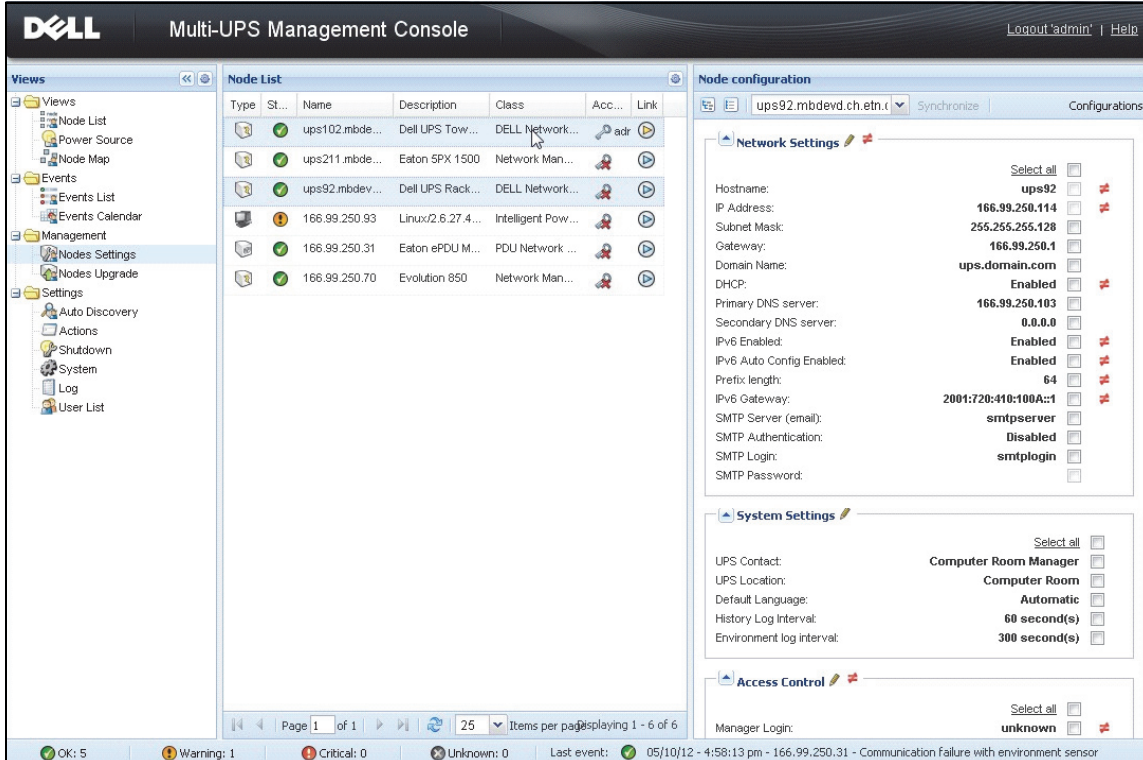





Figure 57. NMC Mass Configuration

Nodes Upgrade

Upload Device Firmware

Perform this procedure to upload a device firmware:

NOTE: Refer to the network cards release notes to determine the latest firmware release compatible with the hardware revision.

- 1 From **Management > Nodes Upgrade**, select the cards on the Node List page.
- 2 From the Node List button , select **Set Login Parameters** and enter the card login and password. The access status changes from: Access Denied () to Access OK ()
- 3 From the **Firmware > Import Firmware File...** list box, the uploading window displays.
- 4 Click **Browse**, select the firmware from a disk accessible from the computer, and click **Open**.

- Click **Firmware > Upload Firmware** to nodes.
The cards will be updated with the firmware selected.
NOTE: Dell PDU firmware upgrade is not supported at this time.

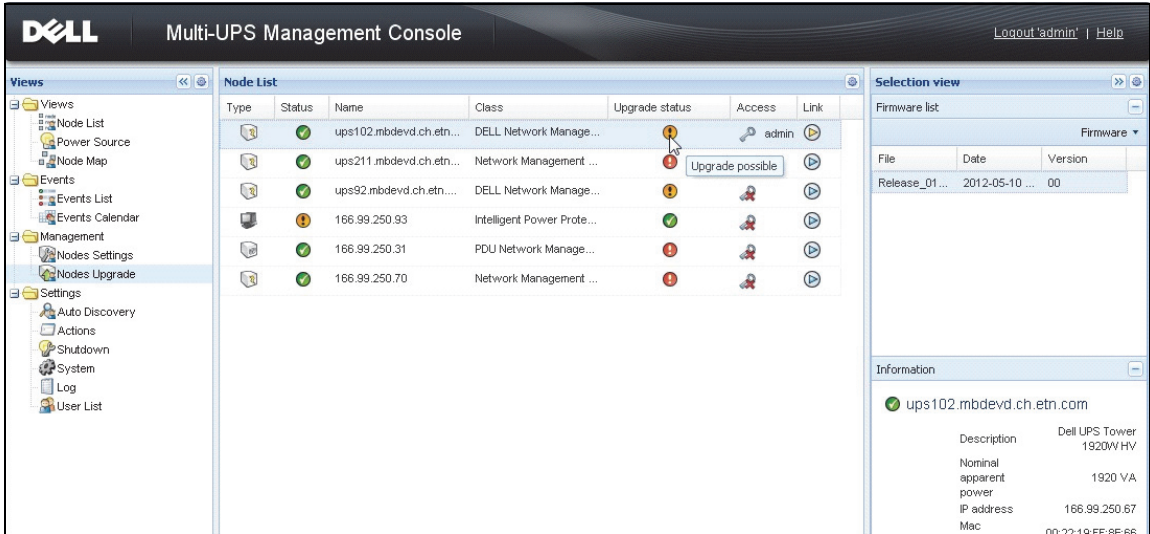





Figure 58. Management / Nodes Upgrade View

Upgrade Applications

Perform this procedure to update the applications:

- Under **Management**, select **Nodes Upgrade**, then select the application (or applications) to upgrade in the Node List (see Figure 59).
- From the Node List button , select **Set Login Parameters**, and enter the access login and password.
The access status changes from: Access Denied () to Access OK ()

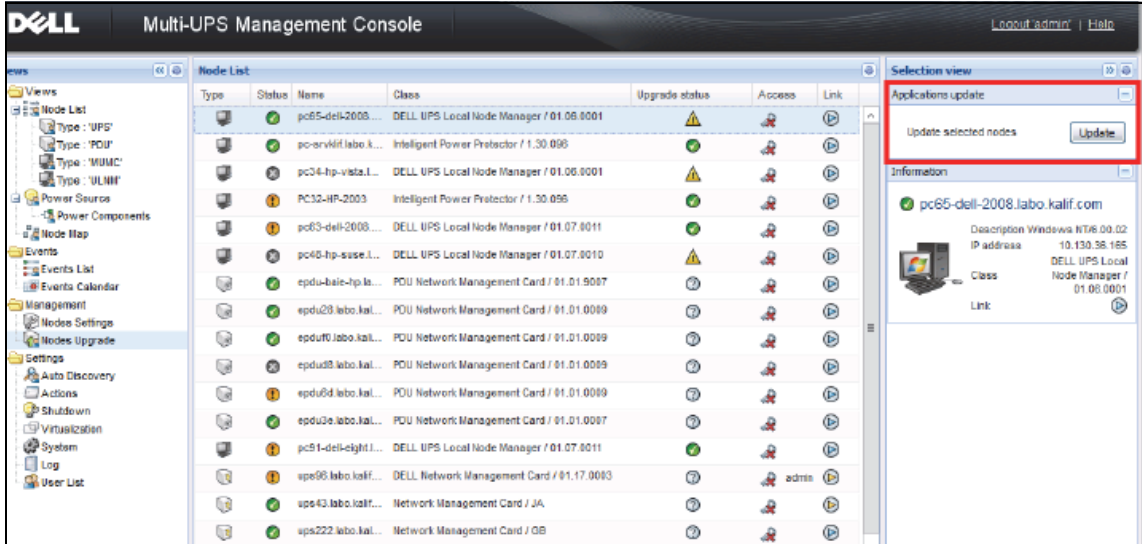

Figure 59. Management / Nodes Upgrade View 2

- From the Applications upgrade panel, click **Update** (see Figure 60).
The status of the applications (with respect to the version) is updated.

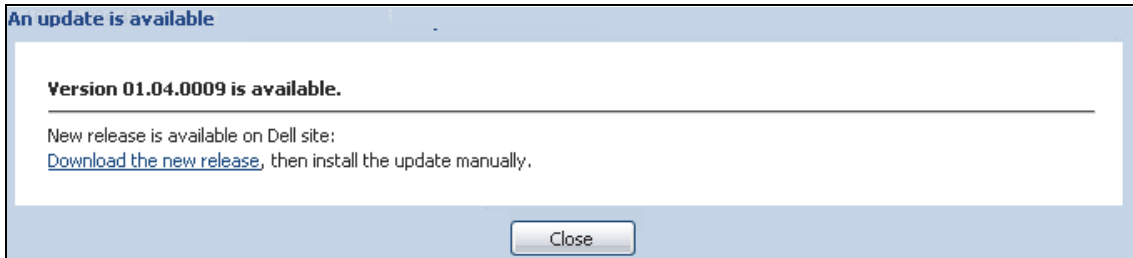

Figure 60. Applications Upgrade Message

Virtualization

The Dell Multi-UPS Management Console (MUMC) Virtualization module for VMware and Hyper-V requires the Dell Network Management Card. For VMware environments managed by vCenter, only the Dell MUMC application is required. For VMware environments without vCenter and all other virtualization platforms, Dell UPS Local Node Manager (ULNM) must be installed on all hosts and configured to communicate with the UPS Dell Network Management Card.

NOTE: USB/RS-232 communication protocols are not supported for virtualization applications.

The Dell MUMC Virtualization module will retrieve information from the hypervisor (for example, VMware® ESX™, VMware® ESXi™, and Citrix® XenServer™) or manager (for example, VMware® vSphere™ and Microsoft® System Center Virtual Machine Manager® [SCVMM]).

The Dell MUMC can execute advanced virtualization features on UPS Power Events:

- Trigger the move of the virtual machines to other hosts by setting the VM host into maintenance mode. The data center will benefit with this zero down-time feature.
- Trigger Shutdown of the VM Host through vCenter. The data center will benefit from hosts graceful shutdown. With other platforms, this function is done by the Dell ULNM application.

Dell Multi-UPS Management Console Virtualization Solutions for VMware, Microsoft, Citrix, OpenSource Xen, and KVM

Dell Solutions for VMware

Dell provides three solutions for VMware that are illustrated in Figure 61.

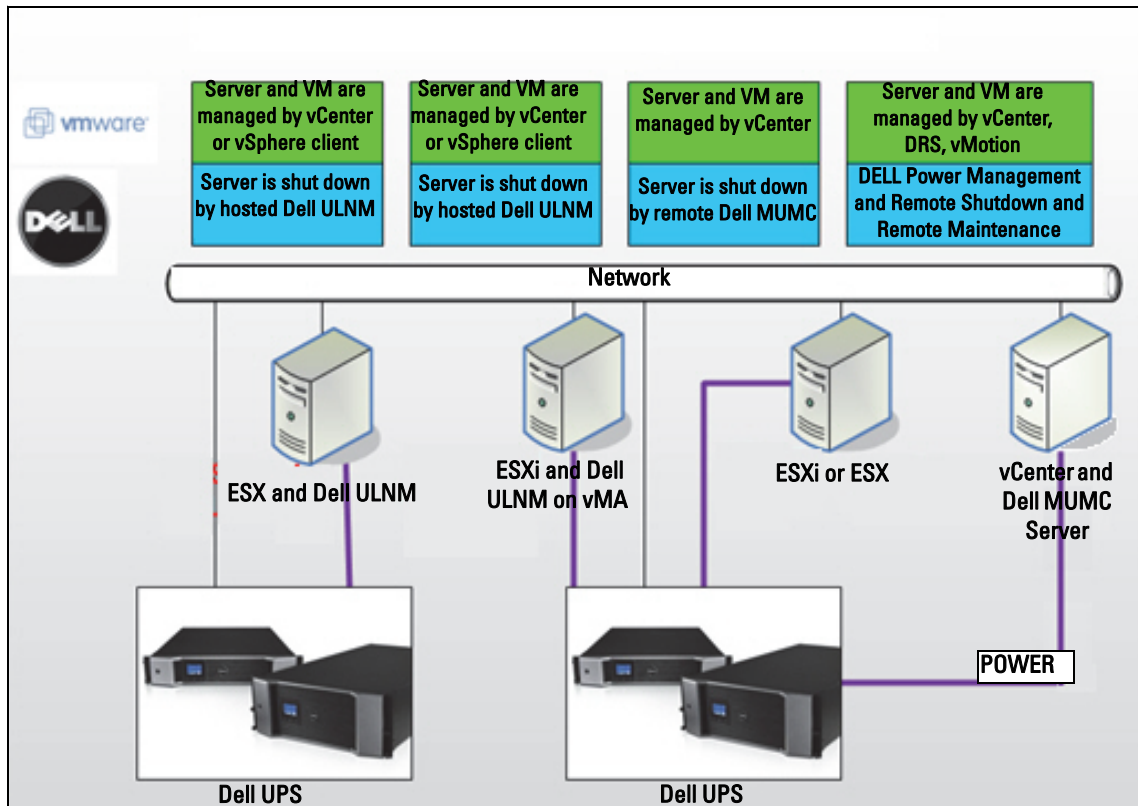

Figure 61. Dell ULNM and Dell MUMC Configurations for VMware

Solution 1

In this solution, ESX and ESXi hosts are controlled by vCenter (paid version only), which provides following features:

- Agentless host management (Dell ULNM does not need to be installed on each host)
- No CLI programming, or need for vSphere Management Assistant (vMA)
- Remote graceful shutdown of multiple ESX/ ESXi servers and hosted VMs

- Ability to set hosts to maintenance mode (to use VMware® vMotion™)
- A plug-in is created in vCenter for centralized IT and power management
- UPS events are accessible and configurable through vCenter

Solution 2

In this solution, ESX and ESXi hosts are not controlled by vCenter (paid version only), which provides following features:

- Dell ULNM application is installed on VMware Infrastructure Management Agent (VIMA) / vMA for each host
- Dell ULNM configurations and actions can be managed centrally from the Dell MUMC client
- Some command line programming is required
- Remote graceful shutdown of multiple ESX / ESXi servers and hosted VMs

NOTE: For paid versions, VMware suppresses the ability to control VM shutdown profiles in non-licensed ESXi installations. There are third-party methodologies for avoiding this restriction, but this is not covered in this user guide.

Solution 3

This solution is for ESX-only hosts (paid or free versions), which provides following features:

- Dell ULNM application is installed on each host (on either Windows or Linux VM)
- Remote graceful shutdown of each ESX host and hosted VMs
- Dell ULNM configurations and actions can be managed centrally from Dell MUMC client

Dell Solutions for Microsoft

For Microsoft, Dell MUMC provides two solutions that are illustrated in Figure 62.

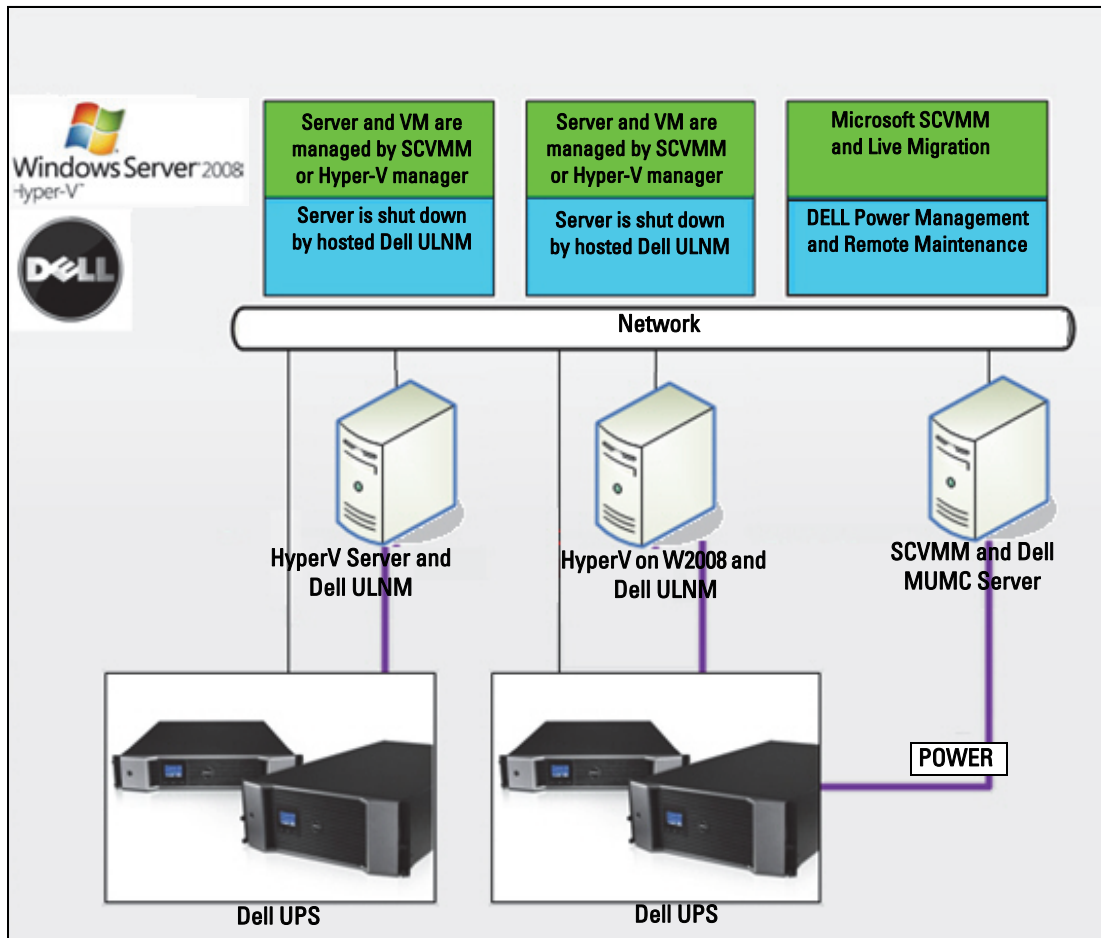

Figure 62. Dell ULNM and Dell MUMC Configurations for HyperV

Solution 1

The first solution provides graceful shutdown for Microsoft® Hyper-V or Hyper-V Server® on 2008. Dell ULNM is installed on each Microsoft operating system.

NOTE: This solution does not require SCVMM management software.

Solution 2

The second solution is for multiple Hyper-V and Hyper-V servers.

It provides following features:

- Hyper-V / Hyper-V server remote maintenance to trigger VM live migration.
- This solution is ideal for biggest infrastructures working through SCVMM server .

NOTE: See Chapter 6, “ULNM with Microsoft Hyper-V or Hyper Server” in the *Dell™ UPS Local Node Manager® Installation and Configuration User’s Guide*.

Dell Solutions for Citrix Xen

For Citrix® Xen®, Dell MUMC provides two solutions that are illustrated in Figure 63:

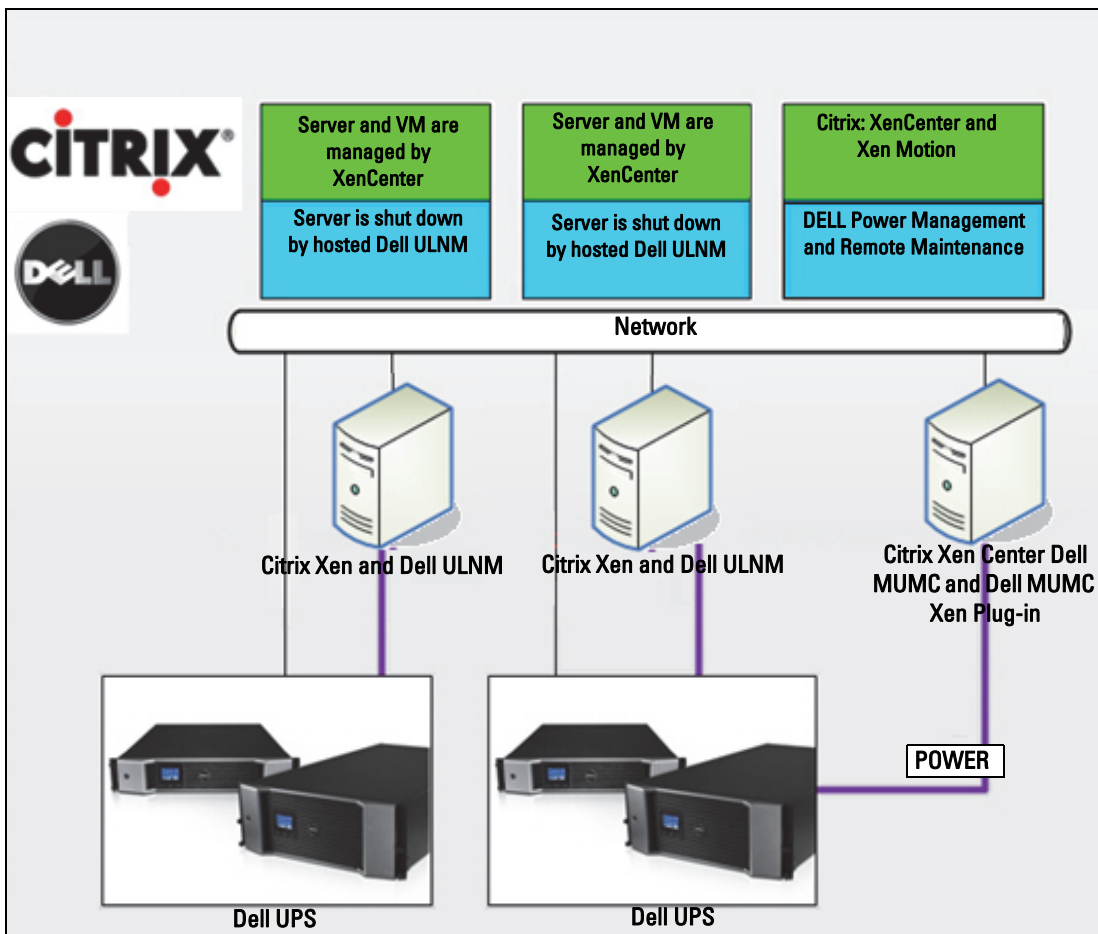

Figure 63. Dell ULNM and Dell MUMC Configurations for Citrix XenServer

Solution 1

The first solution provides the following:

- Provides graceful shutdown for Citrix Xen.
- Dell ULNM is installed on each Citrix Xen system.
- This solution does not require Citrix® XenCenter® management software.

Solution 2

The second solution is for multiple Xen servers. It provides following features:

- Xen server Remote maintenance to trigger VM Citrix® XenMotion®.
- Xen server Remote shutdown.
- This solution is ideal for biggest infrastructures working through Citrix XenCenter.

This solution is now integrated in Dell MUMC.

NOTE: See Chapter 9, “ULNM with Xen Virtualized Architecture” in the *Dell™ UPS Local Node Manager® Installation and Configuration User’s Guide*.

Dell Solutions for OpenSource Xen

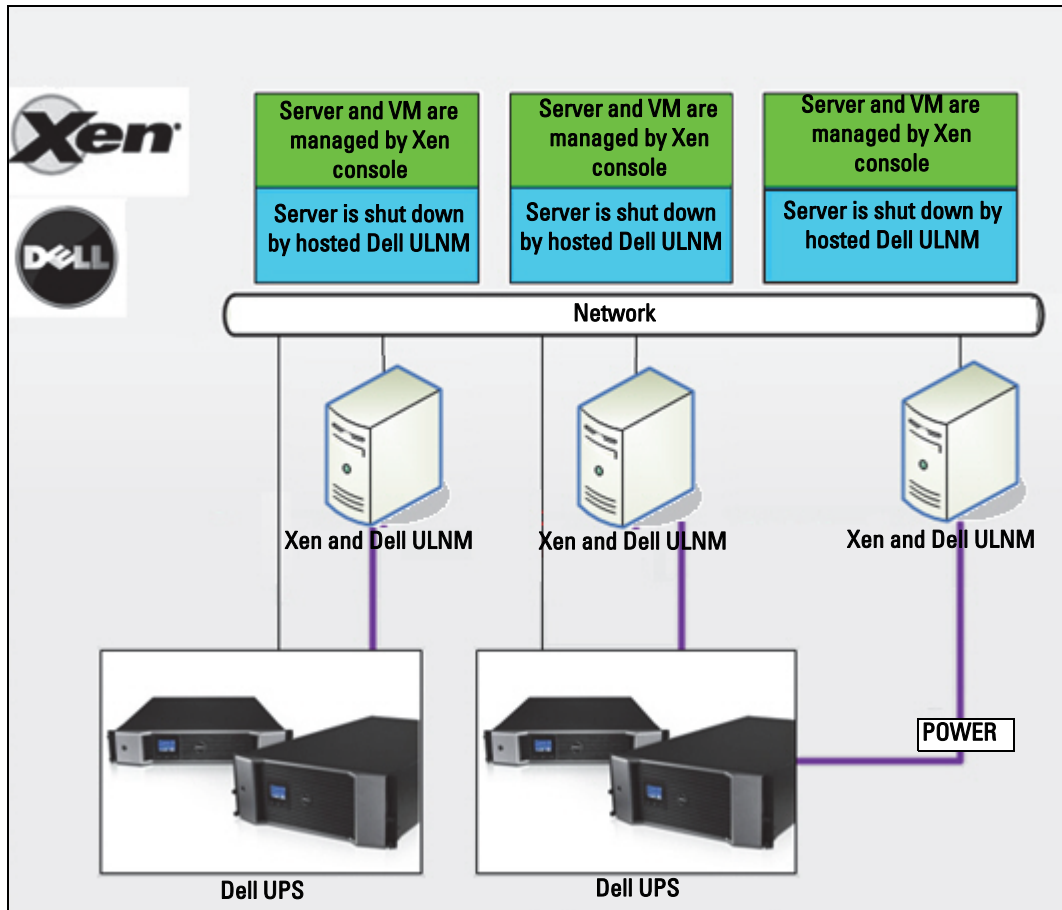

Figure 64. Dell ULNM Configurations for OpenSource Xen

Dell MUMC provides a solution for OpenSource Xen that is illustrated in Figure 64:

Solution

- It provides graceful shutdown for Xen. Dell ULNM is installed on each Xen system.

NOTE: See Chapter 9, "ULNM with Xen Virtualized Architecture" in the *Dell™ UPS Local Node Manager® Installation and Configuration User's Guide*.

Dell Solutions for Red Hat KVM or OpenSource KVM

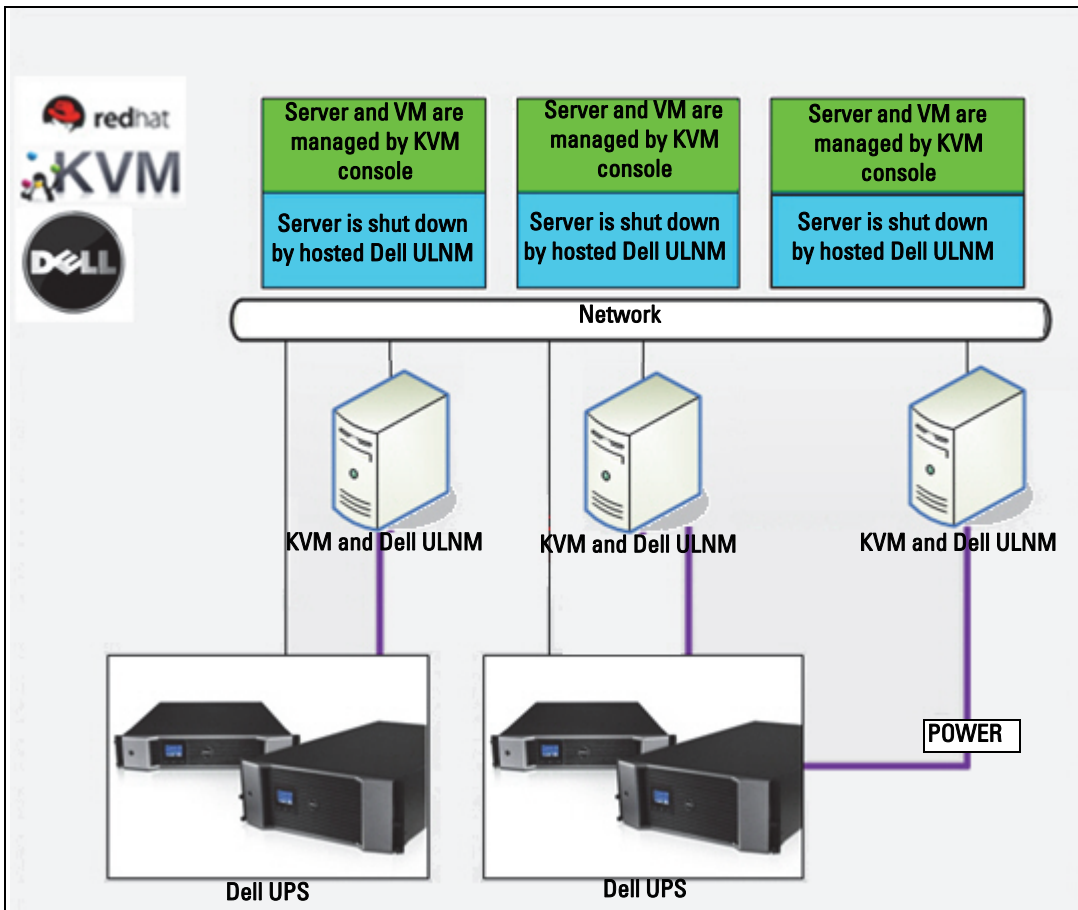

Figure 65. Dell ULNM Configurations for Red Hat KVM or OpenSource KVM

Dell MUMC provides a solution for Red Hat® KVM and OpenSource KVM that is illustrated in Figure 65.

Solution

- It provides graceful shutdown for KVM. Dell ULNM is installed on each KVM system.

NOTE: See Chapter 10, “ULNM with KVM Virtualized Architecture” in the *Dell™ UPS Local Node Manager® Installation and Configuration User's Guide*.

Dell Solutions for Citrix XenClient

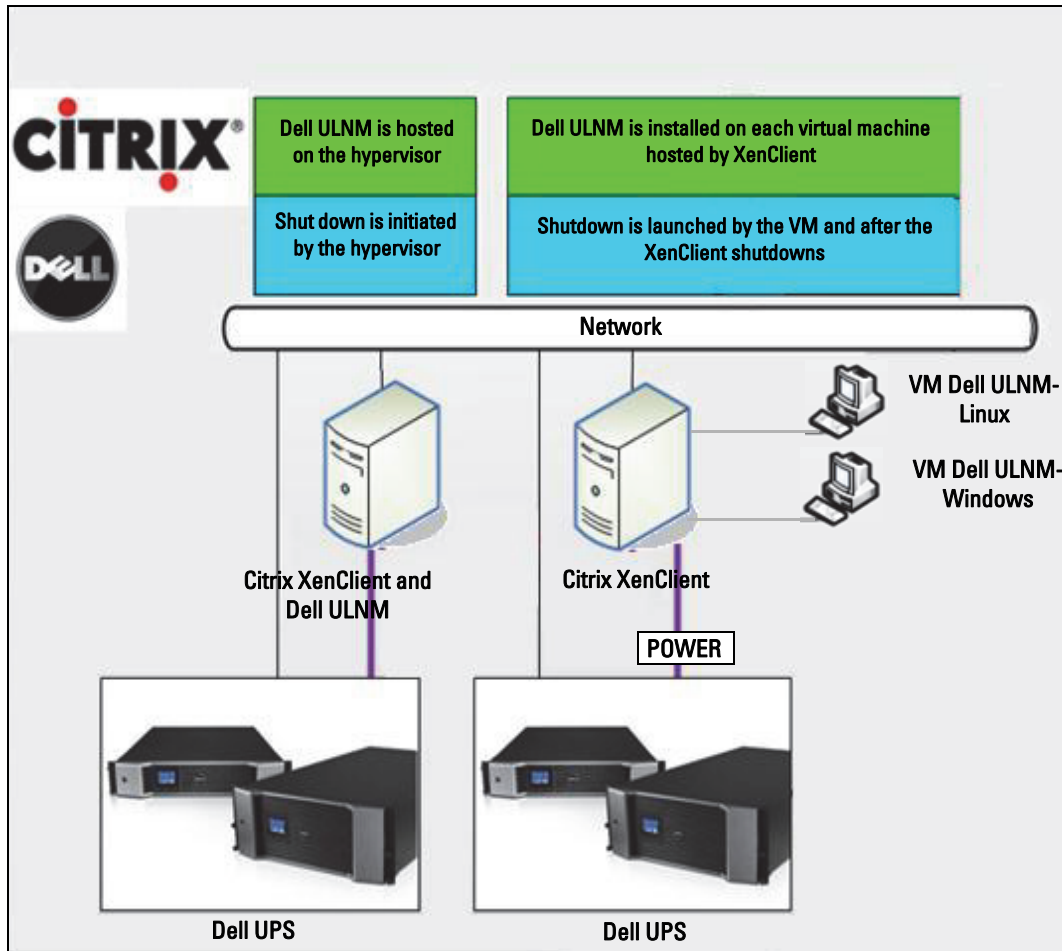

Figure 66. Dell ULNM Configurations for Citrix XenClient

Dell MUMC provides following solution for Citrix® XenClient® that is illustrated in Figure 66.

Solution

- It provides graceful shutdown for Citrix XenClient. Dell ULNM is installed on each Citrix XenClient system or on each virtual machine.

NOTE: See Chapter 9, “ULNM with Xen Virtualized Architecture” in the *Dell™ UPS Local Node Manager® Installation and Configuration User’s Guide*.

Tested environments

Dell has validated the Virtualization module in following environments. Other environment may also be compatible with Virtualization module but are not officially tested.

VMware

- VMware vCenter 5.0 on Windows Server 2008 x64 and Windows Server 2008 R2 x64, Windows Server 2003 x64, Windows Server 2003 R2 x64,
- VMware vCenter Server 4.1/4.0 on Windows Server 2008 R2, 2008 Enterprise 64 bits, 2008 Standard 32 bits and 2003 64bits
- VMware ESXi 5.0/4.1/4.0 (remote shutdown from Dell MUMC or with Dell ULNM on vMA)
- VMware ESX 4.1/4.0 (shutdown with Dell ULNM on core OS)

Microsoft

- SCVMM on Windows Server 2008 R2
- Windows Server 2008 R2 with Dell UPS Local Node Manager (ULNM)

Citrix

- Citrix XenServer 5.6 and 6.0.0
- Citrix XenCenter 5.6 and 6.0.0

Enabling the Virtualization Module

Enable the Virtualization module in the **System > Module Settings** panel (see Figure 67).

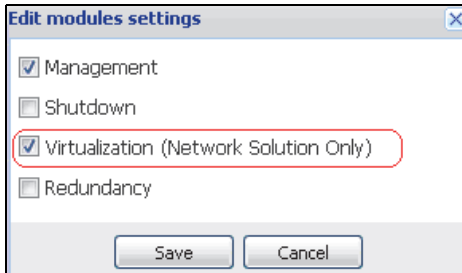

Figure 67. Enable Virtualization

VMware Supervisors Prerequisites

The virtualization module requires the following prerequisites:

- VMware vCenter and VMware vSphere Client must be installed.
NOTE: vCenter and Dell MUMC could be installed on the same server (or on a VM/Server on the network)
- To provide the VM graceful shutdown, you have to install VMware tools on each VM.
- You must also have a knowledge / experience with Dell MUMC software and VMware infrastructure.

NOTE: Since Dell MUMC Release 2 (Version 01.04), the VMware vSphere Software Development Kit (SDK) for Perl is no longer required.

Microsoft Supervisors Prerequisites

The virtualization module needs following prerequisites:

- The Powershell Snapin for Microsoft SCVMM. Either install the VMM console on the machine hosting Dell MUMC, or install Dell MUMC on the machine hosting SCVMM.
- The server hosting Dell MUMC must be on the same Windows Domain than SCVMM Server
- The server hosting Dell MUMC must enable the execution of third party scripts on the local machine (minimum access “Remote Signed,” for example: Set-ExecutionPolicy RemoteSigned).

Figure 68 displays the parameters after the configuration example:

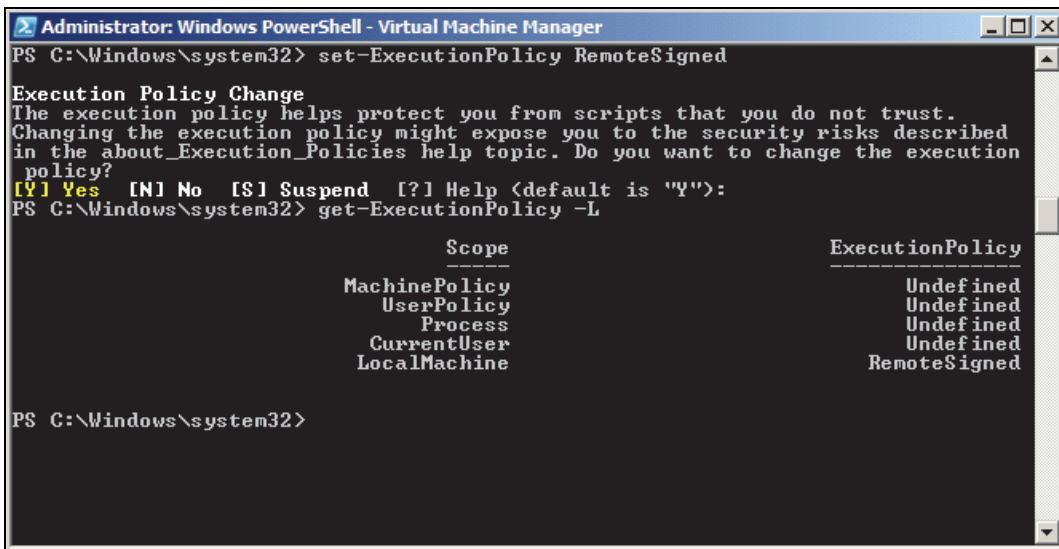

```
Administrator: Windows PowerShell - Virtual Machine Manager
PS C:\Windows\system32> set-ExecutionPolicy RemoteSigned

Execution Policy Change
The execution policy helps protect you from scripts that you do not trust.
Changing the execution policy might expose you to the security risks described
in the about_Execution_Policies help topic. Do you want to change the execution
policy?
[Y] Yes [N] No [S] Suspend [?] Help (default is "Y"):
PS C:\Windows\system32> get-ExecutionPolicy -L

Scope                                     ExecutionPolicy
-----
MachinePolicy                             Undefined
UserPolicy                                 Undefined
Process                                    Undefined
CurrentUser                                Undefined
LocalMachine                               RemoteSigned

PS C:\Windows\system32>
```

Figure 68. Windows PowerShell - Virtual Machine Manager

Citrix Supervisors Prerequisites

The Virtualization module needs the following prerequisites:

- XenCenter must be installed to manage the XenServers.
- To provide the VM graceful shutdown, you must install Xen tools on each VM.

Adding Manager or Hypervisor List

Introduction

To add a manager or hypervisor list:

- 1 Enable the Virtualization module.
A new Virtualization menu entry displays in the “Settings” menu.
- 2 Click this new Virtualization menu entry.
- 3 Select Add Manager or Hypervisor List on the right panel (see Figure 69).

NOTE: To Edit or Remove Managers or Hypervisors, you have to select a line in the center panel first.

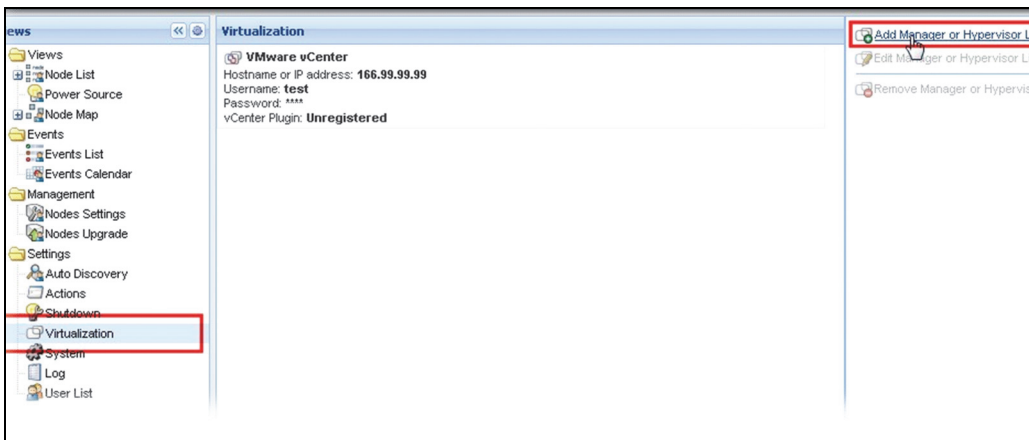

Figure 69. Virtualization module view

The following sections explain how to add different kinds of managers and hypervisors.

Adding a vCenter Server Manager

To add a new VMware vCenter, complete the following fields (see Figure 70):

- **Product:** Type (VMware vCenter)
- **Hostname or IP address:** VMware vCenter Hostname or IP address
- **Username:** VMware vCenter Administrator Username
- **Password:** VMware vCenter Administrator Password.
- **vCenter Plugin:** Installs and configures Dell MUMC Plug-in into vCenter

NOTE: See “Configuring the Dell MUMC vCenter Plugin” on page 108 when using this feature.

Click **Save** after the fields are updated. Your VMware ESXi hosts will automatically be added to the managed nodes.

NOTE: When configuring the Login and Password, we recommend using the Dell MUMC Web interface through https. Using http is also possible but the Password is sent to the local or remote server in clear. In both cases, the password is stored encrypted in Dell MUMC and never sent again on the Client side.

The encrypted password is stored in the following configuration file ({DELL MUMC INSTALL DIRECTORY}\configs\vmconfig.js).

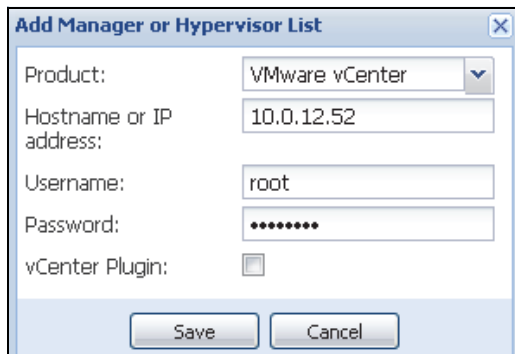

Figure 70. Add VMware vCenter

Adding a SCVMM Manager

To add a new Microsoft SCVMM, complete the fields below (see Figure 71):

- **Product:** Type (Microsoft SCVMM)
- **Hostname or IP address:** Microsoft SCVMM Hostname or IP address

Click **Save** after the fields are updated.

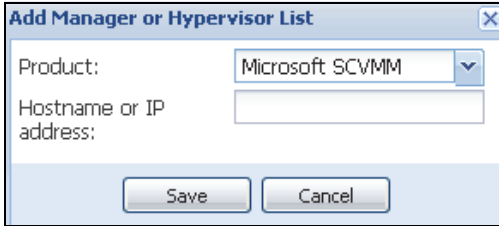

Figure 71. Add Microsoft SCVMM

Adding a VMware ESX/ESXi Hypervisor List

In the case where you do not have a vCenter server manager, add new VMware ESX/ESXi hosts individually. Complete the following fields (see Figure 72):

- **Product:** Type (VMware ESX/ESXi)
- **Hostname or IP address:** List of VMware ESX/ESXi Hostname or IP address

Click Save after the fields are updated.

NOTE: The Dell ULNM application must already be installed on each host's VIMA or vMA

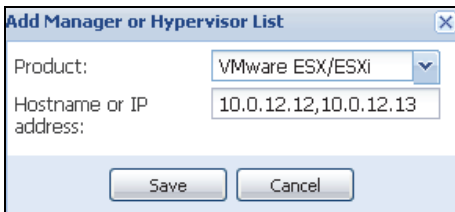

Figure 72. Add VMware ESX/ESXi

Adding a Citrix XenServer Hypervisor List

To add a new Citrix XenServer List, complete the fields below (see Figure 73):

- **Product:** Type (Citrix XenServer)
- **Hostname or IP address:** List of Citrix XenServer Hostname or IP address

Click Save after the fields are updated.

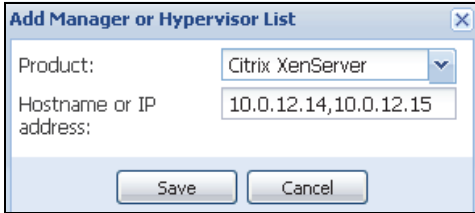

Figure 73. Add Citrix XenServer

Adding a XenCenter

As Citrix XenCenter is a Client and not a Manager, you can install a plug-in on the system where XenCenter is installed (see Figure 74). This plug-in allows the user to use Dell MUMC into XenCenter. Click Save after the fields are updated.

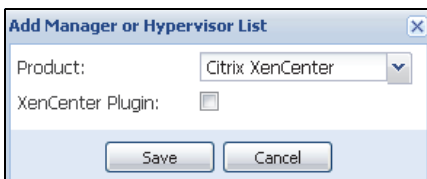

Figure 74. Add Citrix XenCenter

Configuring Hypervisors (ESX/ESXi Server, XenServer)

Introduction

For VMware vCenter or Microsoft SCVMM installation in Dell MUMC:

- After you have entered the correct information for the Manager, the Dell MUMC connects to the Manager (vCenter or SCVMM).
- Dell MUMC automatically retrieves the VMHost information and creates new nodes in Dell MUMC for each VMhost
- Dell MUMC automatically creates two different types of nodes that will be described after (you can see the new node in the Node List)
- There is no need to enter the credentials for the hosts in the Node Settings menu. The VMware vCenter credentials are all that is required to manage the system.
- You can now continue to “Configuring Maintenance and Shutdown” on page 94.

For individual host installation (no vCenter or SCVMM) in Dell MUMC:

- After you have “Added a new list of Hypervisor,” Dell MUMC creates new nodes and waits for the credential.
- You can now continue to the “Credential Configuration for the Hypervisors (ESX/ESXi, XenServer)” section.

Credential Configuration for the Hypervisors (ESX/ESXi, XenServer)

- You have to configure the node credential in the Node Configuration Panel (see Figure 75).
- After you have entered the correct information, Dell MUMC will retrieve Hypervisors information.
- You can now continue to “Configuring Maintenance and Shutdown” on page 94.



Figure 75. Node Configuration Panel

Configuring Maintenance and Shutdown

Introduction

After you have entered the correct credential information for your managers and hypervisors, you have to configure the Maintenance and Shutdown sequences according to the availability needs of your IT infrastructure when power fails.

Configuration Options for vCenter and SCVMM Installations

Click each host in the Nodes Settings menu item and configure the required parameters:

- **Remote Maintenance:** Enabled or Disabled. When enabled, the MUMC client sets the host to “Maintenance Mode.” Depending on your host/cluster configuration, this can trigger vMotion/live migration to another host. This event is triggered at the time set in the “Maintenance Timer” parameter.
- **Maintenance Timer:** Time elapsed “on battery state” before the Dell MUMC script changes the state of the host to maintenance mode
- **Remote Shutdown:** Enabled or Disabled (When enabled, it allows Dell MUMC to gracefully shutdown this server in case of “UPS on battery state” and Shutdown criteria reached)

- **Remote Shutdown of the Virtual Machines:** Enable Dell MUMC to shut down the virtual machines
- **Power Source:** UPS powering this server (this node has to exist already in Dell MUMC)
- **Load Segment:** UPS load segment powering the server
- **Master - Shutdown Duration:** Server Shutdown criteria (time needed for graceful host shutdown)
- **Master - Shutdown After Value:** Server Shutdown criteria, which is the time elapsed “on battery state” before graceful Shutdown. (This timer must be greater than the maintenance timer)

NOTE: The -1 value means that timer is disabled.

Figure 76 illustrates VMware vCenter and Microsoft SCVMM shutdown settings before configuration. Figure 77 illustrates VMware vCenter and Microsoft SCVMM shutdown settings after configuration.

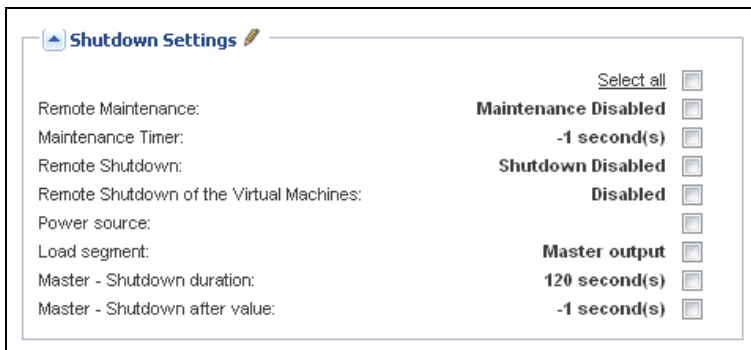

Figure 76. vCenter and SCVMM Shutdown Settings - Before Configuration

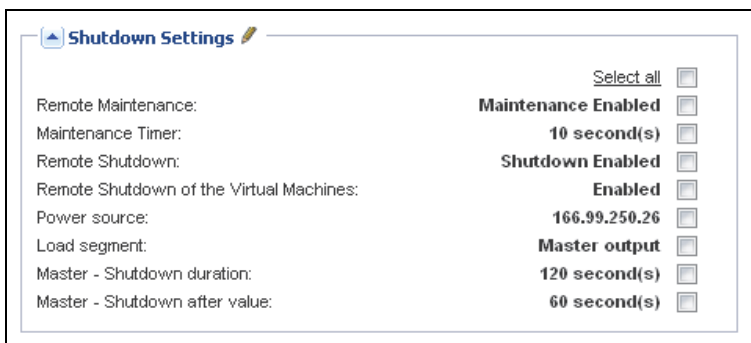

Figure 77. vCenter and SCVMM Shutdown Settings - After Configuration

Figure 78 shows the above settings in the context of an extended power failure.

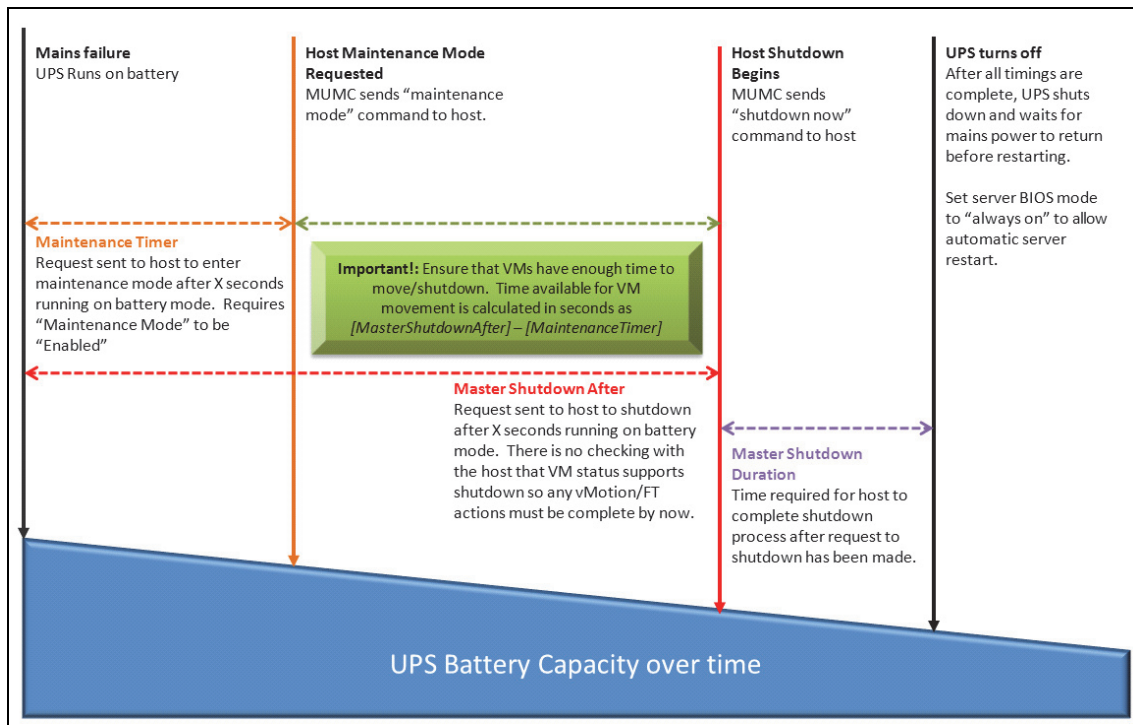

Figure 78. UPS Battery Capacity Over Time

NOTE: The Remote Shutdown functionality within Dell MUMC is reserved for VMware ESX/ESXi and Citrix XenServer nodes. (Microsoft Hyper-V uses Dell ULNM on the host to perform shutdown).

NOTE: The Remote Shutdown of the Virtual Machines is only applicable to VMware ESX/ESXi hosts.

CAUTION: You must set the "Shutdown after value" to a time when all maintenance mode and VM migrations have completed. If VM migrations have not completed by the time the "Shutdown" command is sent to the host, it will override the migration request and migration will fail. No data will be lost because the image synchronization will have failed, but the VM will cease to operate.

Second Type of Nodes (DELL MUMC Detects Dell ULNM Running on the VMHost)

If there is a Dell ULNM installed on the server that is hosting the Hypervisor (VMHost), the shutdown is done by the Dell ULNM.

In this case, the node contains both parameter types:

- The remote maintenance mode feature parameters.
- The Dell ULNM shutdown parameters (as a Dell ULNM will perform the shutdown locally).

NOTE: All the parameters are retrieved from Dell ULNM, and you will configure the Dell ULNM from Dell MUMC in the Node Configuration Panel. See “Nodes Settings” on page 64 for more information on using the configuration interface.

The Shutdown Settings are (see Figure 79):

- **Remote Maintenance:** Enabled or Disabled. When enabled, the Dell MUMC client sets the host to “Maintenance Mode.” Depending on your host/cluster configuration, this can trigger vMotion/live migration to another host. This event is triggered at the time set in the “Maintenance Timer” option (below).
- **Maintenance Timer:** Time elapsed “on battery state” before the Dell MUMC script changes the state of the host to maintenance mode.

NOTE: The -1 value means the timer is disabled. See “Configuring Maintenance Mode and vMotion with vCenter” on page 113 and “Configuring Maintenance Mode and Live Migration with SCVMM” on page 116 for more information.

- **Remote Shutdown:** Enabled or Disabled (When enabled, it allows Dell MUMC to gracefully shutdown this server in case of “UPS on battery state” and Shutdown criteria reached)
- **Remote Shutdown of the Virtual Machines:** Enable Dell MUMC to shutdown the Virtual Machines
- **Power Source:** UPS powering this server (this node has to exist already in Dell MUMC)
- **Load Segment:** UPS load segment powering the server
- **(NMC Access) Login/Password:** Network Management Card Login/Password that allows Dell ULNM software to control NMC shutdown sequence.
- **Master - Shutdown Duration:** Server Shutdown criteria (time needed for graceful host shutdown)
- **Master - Shutdown After Value:** Server Shutdown criteria, which is the time elapsed “on battery state” before graceful Shutdown. (This timer must be greater than the maintenance timer)

NOTE: The -1 value means the timer is disabled.

- **Power Source Shutoff:** Disabled. Enabled is used only for server connected with UPS through RS-232 or USB. Virtualization behavior requires Ethernet connectivity (Dell Network Management Card).

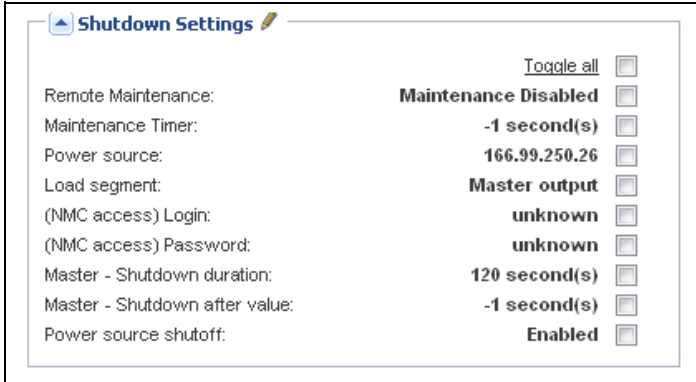

Figure 79. Shutdown Settings Configuration (Second types of nodes)

If you install an Dell ULNM on the VMHost after the Dell MUMC node has been created:

- Delete the node in Dell MUMC.
- Rediscover the node with the “Address Scan” in the Auto Discovery panel.
- Dell MUMC will create the right node type and retrieve both the VMHost information and the Dell ULNM information.

Redundancy

This chapter describes the Dell Multi-UPS Management Console (MUMC) redundancy features.

The Dell MUMC can supervise composite devices. Composite devices are virtual nodes composed of 2 or more UPSs in redundant configuration (Redundant Supplies).

This Redundancy feature is enabled from **Settings > System > Modules Settings** (see Figure 80).

The Dell MUMC will then:

- Supervise composite devices (if Redundancy feature is activated)
- Shutdown the Dell MUMC computer when powered by several UPSs (if shutdown feature is also activated).

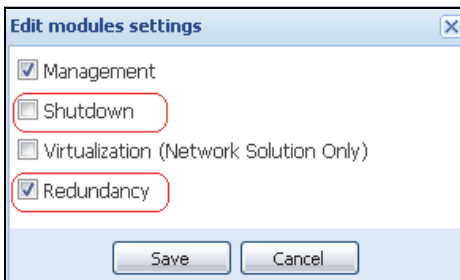

Figure 80. Edit Modules Settings Dialog Box

Figure 81 illustrates the electrical redundancy Redundant Supplies topology. In this case, the two UPSs provide power on one or several multiple feed servers.

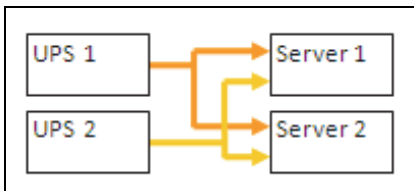

Figure 81. Redundant Supplies Redundancy Schema

Redundancy Configuration

To configure redundancy:

- 1 Login with an administrator user profile.
- 2 Select two or more nodes.
- 3 Click Set composite device (see Figure 82).

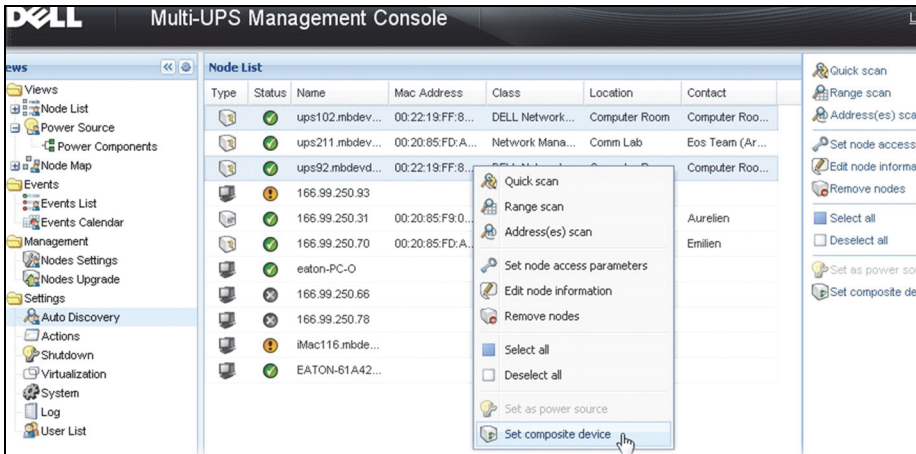

Figure 82. Selecting Set Composite Device for Nodes

- 4 In the dialog box, specify a device name, redundancy mode, and level (see Figure 83):
 - Device Name: User name of the composite device
 - Redundancy Level: The minimal number of redundant UPSs powering your system. The default value is 0.

NOTE: If you set this parameter to a higher level, you will receive the “Redundancy Lost” alarm.

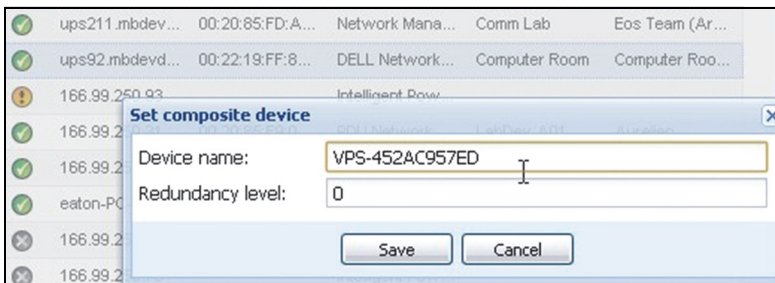

Figure 83. Set Composite Device Dialog Box

Then, the new node is created:

- You can see it in the “Autodiscovery” node list.
- You can select it as power source.
- You can edit composite device properties by selecting it in the discovery view then click again on the “Set composite device” menu item.
- If you select components of a composite device and click on the “Set composite device” menu item again, properties of existing composite device are shown; no new composite device is created so no composite device duplication is possible.
- The created “Virtual Power Source” is counted as a node for the licensing node limitation.

Redundancy Views

Redundancy View in Node List

When a composite device is selected in the node list, the user can view it in the selection view, with following information:

- Dedicated states in “Information” and “Status” panels
- “Events” panel shows events from the composite devices and all its child components

A dedicated “Power components” panel displays component states, including load level and battery run time.

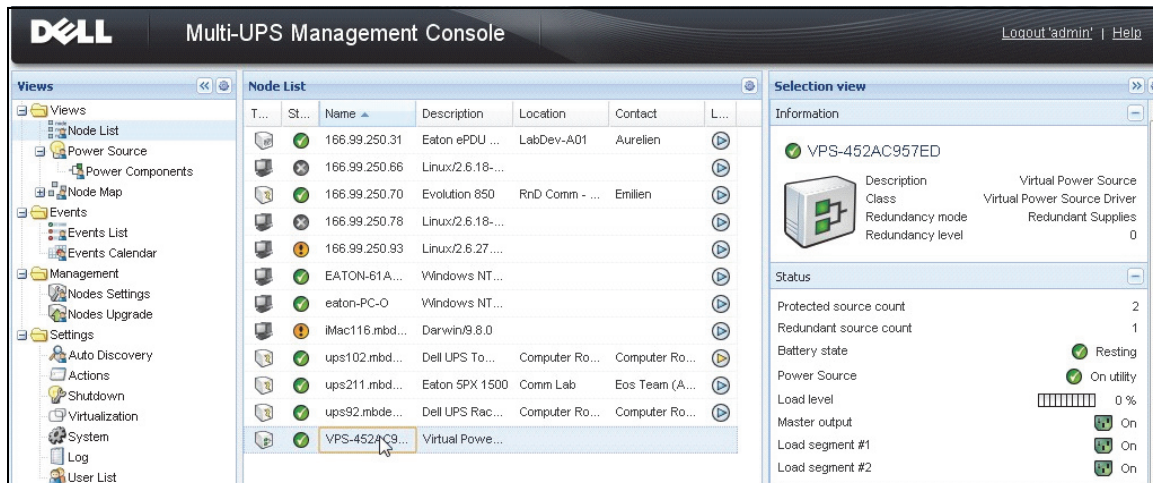

Figure 84. Virtual Power Source in Node List View

Composite Device in Power Source View

When a redundancy and shutdown module is activated, a composite device can be selected as power source. The user can show it in the Power Source view.

In this case, Information, Status, Events, and Power Components panels are displayed with specific data (see Figure 85).

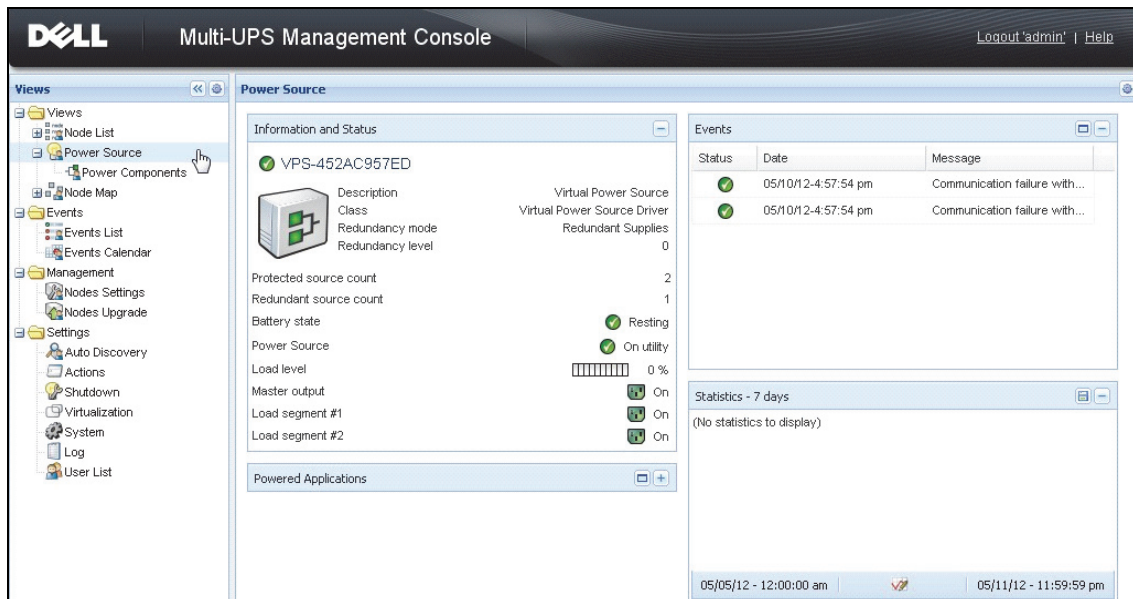

Figure 85. Composite Device Power Source View

Power Components Sub-view

When redundancy and shutdown modules are activated, a new power component view is available as a sub-view of the Power Source view. This view shows a list of nodes with their properties (see Figure 86).

NOTE: This view shows only components of the selected power source if it is a composite device.

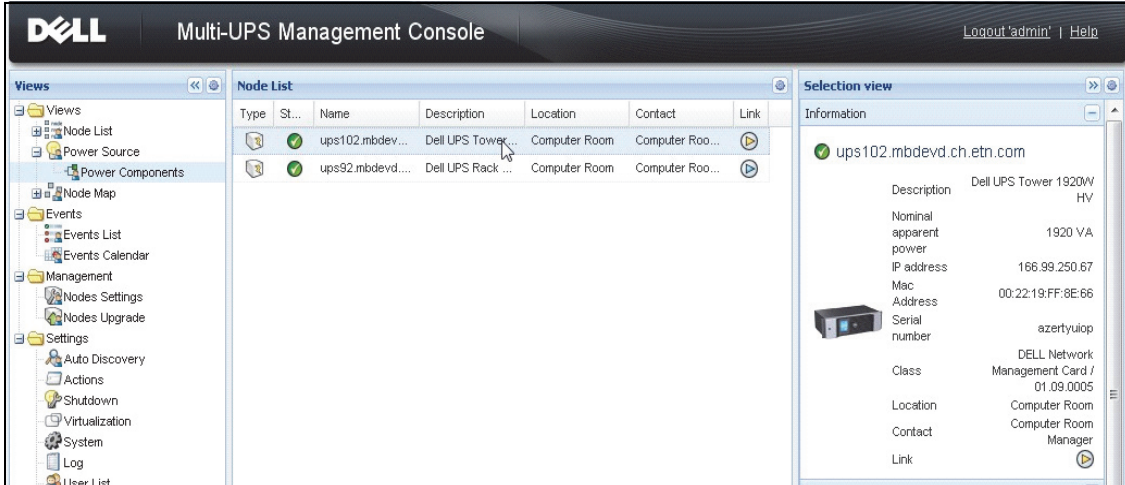

Figure 86. Power Components Sub-view

Redundancy Use Cases

This section describes several typical use cases to help you properly configure the redundant shutdown sequence according to your needs.

Use Case #1

You want to have the longest backup time with the redundant configuration.

- Figure 87 illustrates the Dell MUMC default configuration available from **Settings > Shutdown > Edit Shutdown Configuration**.
- Figure 88 illustrates the Dell Network Management Card default shutdown configuration available from **UPS > Shutdown Parameters**.

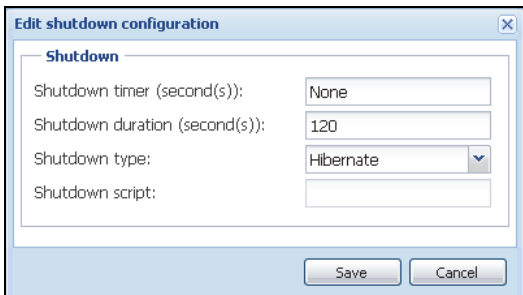

Figure 87. Edit Shutdown Configuration Dialog Box

The screenshot shows the Dell Network Management Card Web Interface. The header includes the Dell logo and 'UPS MANAGEMENT CARD'. The left navigation menu has 'UPS' selected, with 'Shutdown Parameters' highlighted. The main content area is titled 'Shutdown Parameters' and includes a 'Help' link. Below the title, it shows 'Dell UPS Tower 1920W HV' and 'Computer Room'. The main configuration area is a table with four columns: Output, On battery, System Shutdown, and Restart. The table has three rows for different output types: 'On Battery', 'Load Segment1', and 'Load Segment2'. Each row has input fields for 'Shutdown if Remaining time under:', 'Shutdown duration:', and 'Switch On after:'. A 'Show advanced parameters' checkbox is at the bottom, and a 'Save' button is at the bottom right.

Output	On battery	System Shutdown	Restart
On Battery	Shutdown if Remaining time under: 180 sec	Shutdown duration : 120 sec	
Load Segment1	Switch Off after: 600 sec	Shutdown duration : 120 sec	Switch On after: 0 sec
Load Segment2	Switch Off after: 600 sec	Shutdown duration : 120 sec	Switch On after: 1 sec

Save modified settings :

Figure 88. Dell Network Management Card Web Interface

Use Case #2

You want to have a shutdown after a predefined time of 10 min. The shutdown must occur, even if only one UPS is on battery.

- In this case, each server can have its own shutdown timer (10 min, 8 min, 6 min...). To set a predefined time of 10 min, configure the shutdown timer for 10 min in the Edit Shutdown Configuration dialog box.
 - Figure 89 illustrates the Dell MUMC default configuration available from **Settings > Shutdown > Edit Shutdown Configuration**.

NOTE: This is the default configuration on the Dell Network Management Card (refer to previous use case).

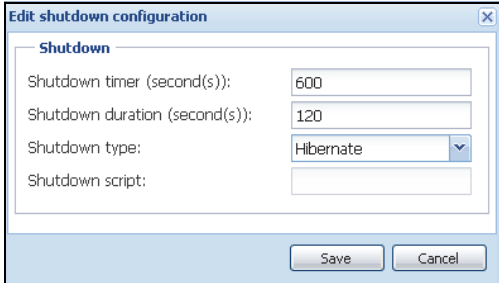

Figure 89. Edit Shutdown Configuration Dialog Box

Use Case #3

You want to start shutdown 10 min from the last detected Utility failure event. For this case, there are two UPSs, and one UPS is redundant. In addition, all servers will be shut down at the same time.

- This is the default Dell MUMC configuration. To configure this shutdown, you must set a shutdown timer of 10 min in all the Dell Network Management Cards. In this case, the last UPS will send the shutdown order after 10 min if it runs on battery. If the last UPS never runs on battery, the first UPS will shut down at the end of autonomy and the last UPS will take the load if it has the capacity. Otherwise, the shutdown will occur sooner.
 - Figure 90 illustrates the Dell Network Management Card Shutdown configuration available from ***UPS > Shutdown Parameters***.

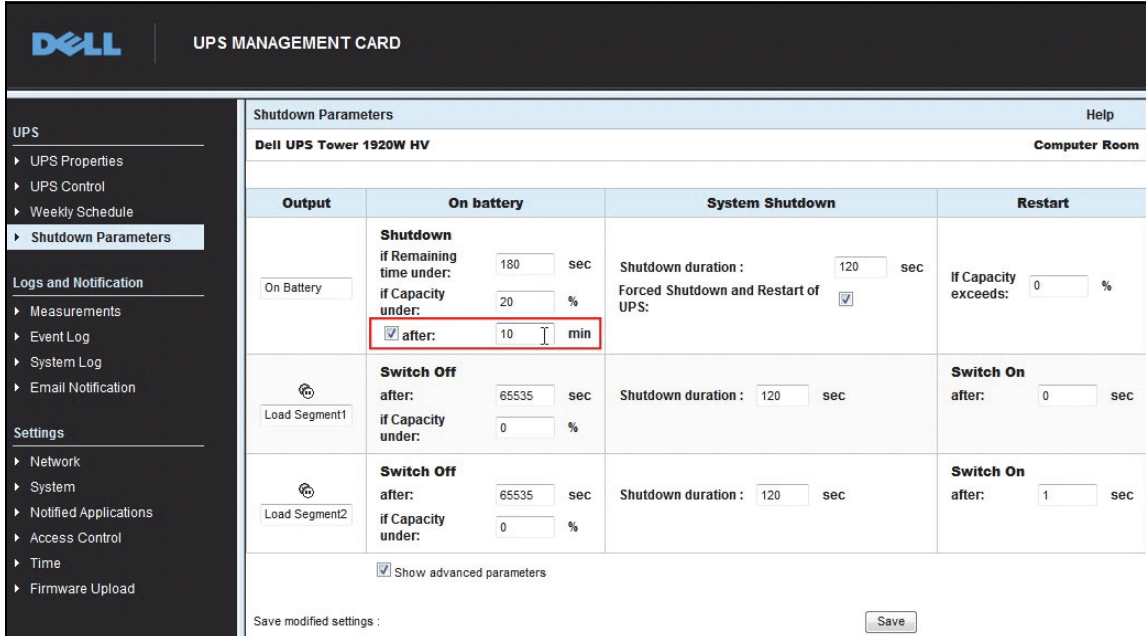

Figure 90. Dell Network Management Card Shutdown Parameters

Use Case #4

You want to have a shutdown when the remaining time of the last UPS is 10 min. In this case, each server can have an individual shutdown duration (10 min, 8 min, 3 min...).

- You need to configure a shutdown duration of 10 min in the Dell MUMC.
 - Figure 91 illustrates the Dell MUMC default configuration available from **Settings > Shutdown > Edit Shutdown Configuration**.

NOTE: This is the default configuration on the Dell Network Management Card (refer to the previous use case).

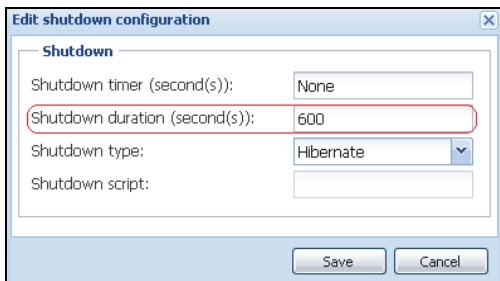

Figure 91. Edit Shutdown Configuration Dialog Box

Applying Extended Functionality

Configuring the Dell MUMC vCenter Plugin

The VMware vCenter Server platform forms the foundation for virtualization management. It provides management of hosts and virtual machines from a single console. To further unlock the power of VMware's management system, VMware has provided a facility to extend the functionality of VMware vCenter.

Various useful applications can be attached to vCenter to make it more useful. The Dell Multi-UPS Management Console (MUMC) vCenter Plug-in is also called Dell MUMC Plug-in vCenter. It is a very easy to use and deploy Plug-in to manage the Dell MUMC from vCenter. This plug-in integrates the Dell MUMC with vCenter environment. After the plug-in is deployed, a tab in vCenter will open the Dell MUMC and allow users to configure and manage it from vCenter environment.

The VMware plug-in also allows the creation of new type of events that can be trig-type of alarms.

Checking for vCenter Plug-in Registration

To check to see if the Dell MUMC plug-in is registered in vCenter:

- 1 In the VMware vSphere Client, select **Plug-ins > Manage Plug-ins** (see Figure 92).
- 2 Dell MUMC Plug-in for vCenter can be seen in the Plug-in Manager (see Figure 93).

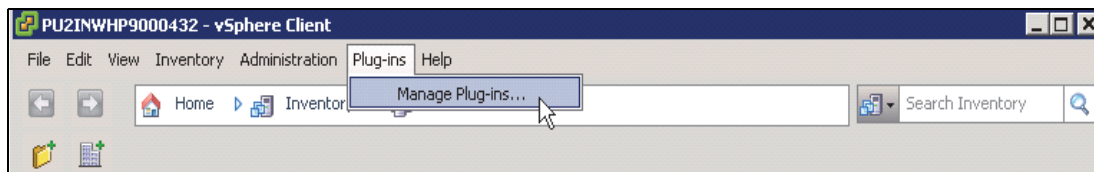

Figure 92. vSphere Client - Manage Plug-in Menu

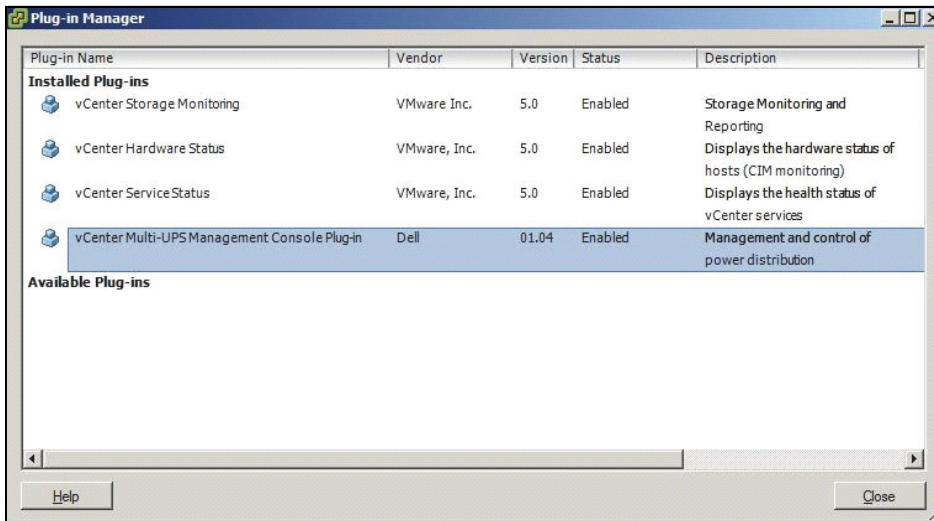

Figure 93. vCenter Plug-in Manager

Events and Alarms

After the “vCenter Dell Multi-UPS Management Console Plug-in” is registered, Dell MUMC creates a new alarm “Host UPS PowerFailure (On Battery)” that is triggered from power event (see Figure 94).

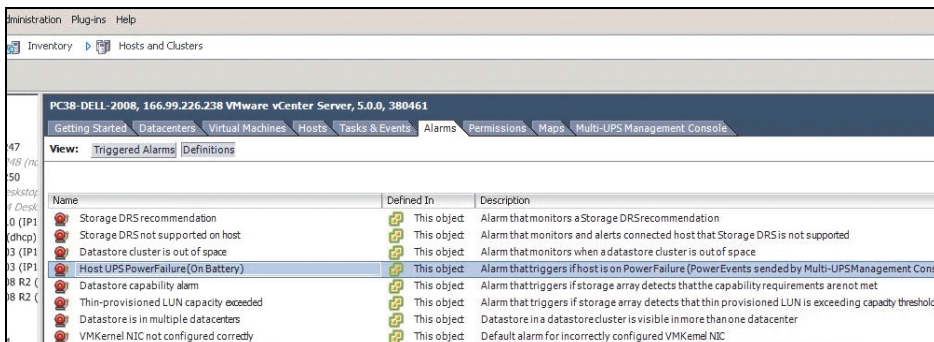

Figure 94. vCenter New Alarm from Dell MUMC

Using Dell MUMC through vCenter

The Dell MUMC tab will now be visible in the vCenter Server Console and in the root folder  (see Figure 95).

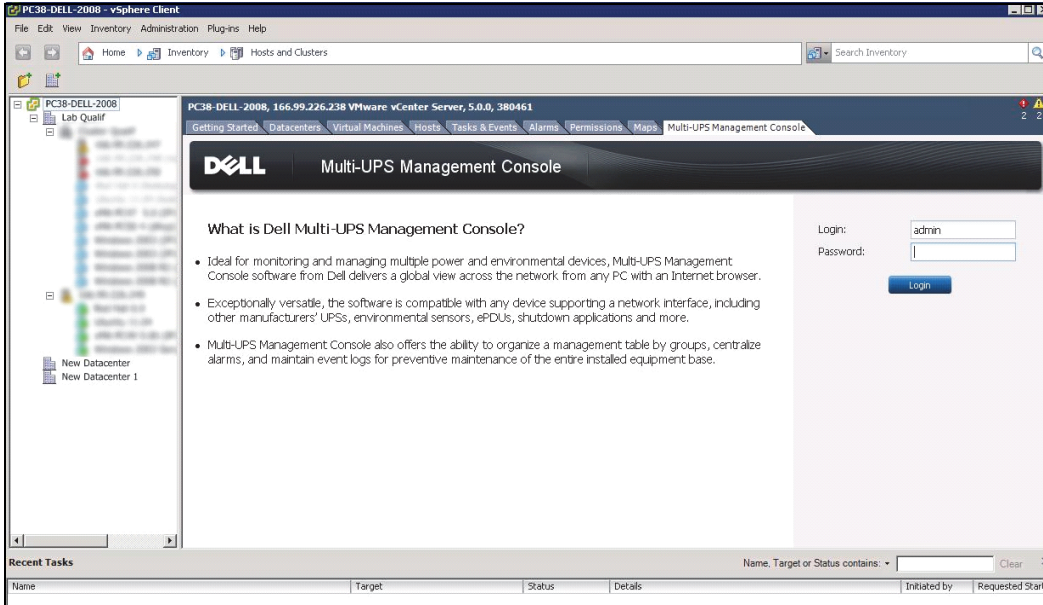

Figure 95. vCenter Server Console

The Dell MUMC is now available and is fully functional with the vSphere Client. The Dell MUMC screen is shown in Figure 96. Note that the “Dell Multi-UPS Management Console” tab on the top is selected.

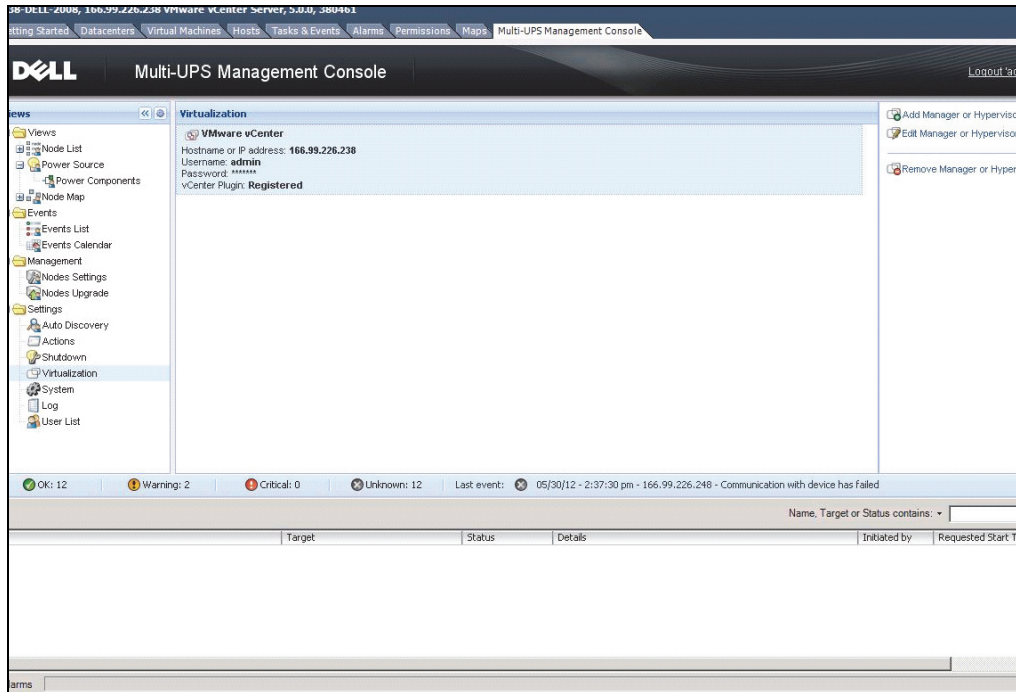

Figure 96. vSphere Client with Dell Multi-UPS Management Console Tab

Configuring XenCenter Plug-in

Prerequisites

The only prerequisite is to have Dell MUMC installed on the same machine as Citrix® XenCenter™.

Check XenCenter Plug-in Installation

- In the virtualization panel, you have to check the box “XenCenter Plugin” to install XenCenter Plug-in.
- You will see the *Plugin in XenCenter > Tools > Plugins*.
- If not, click *Re-scan Plug-in Directory* (see Figure 97).

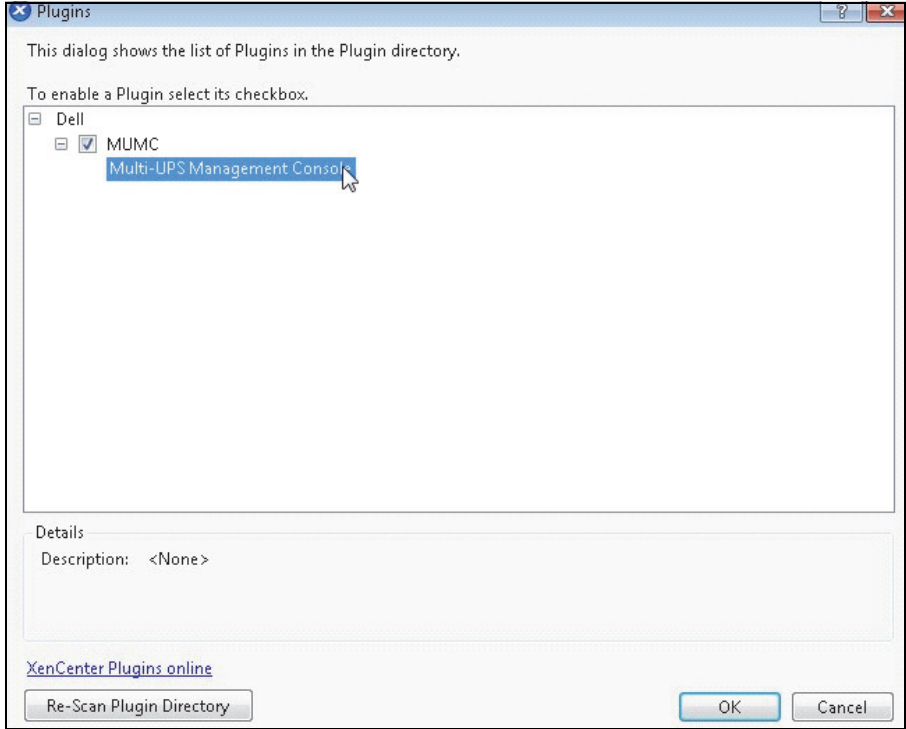

Figure 97. Plugin Directory (Rescan)

Using Dell MUMC through XenCenter

After the Plug-in is installed, you can see a tab named “Dell Multi-UPS Management Console” on the XenCenter level (see Figure 98).

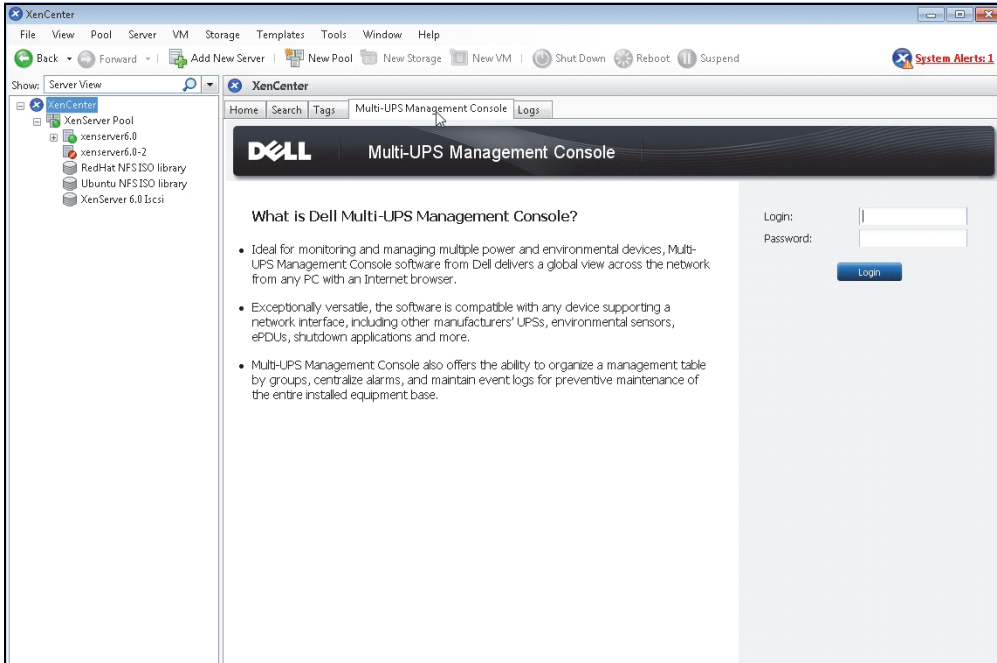

Figure 98. XenCenter Dell MUMC Tab

Configuring Maintenance Mode and vMotion with vCenter

Prerequisites

All virtual machine images have to be installed and configured on a file server.

NOTE: For more information, see “VMware References” on page 117.

Introduction

The Dynamic Resource Scheduler (DRS) application from VMware is used to provide load balancing within the IT network. In particular, DRS is used to ensure the right resource capacity is available for the data center load. A second application called VMware vMotion if used in conjunction with DRS will enact movement of virtual machines from physical server to physical server in order to provide the best load balance.

The Distributed Power Manager (DPM) application will help maximize data center electrical power efficiency by checking DRS for physical server utilization then using vMotion, will move Virtual machines to servers in order to fully unload servers than idle them or power them down for maximum power savings.

Dell uses the same vMotion capability when a UPS is in a critical power situation to move virtual machines off of a server that has a critical power situation. Dell MUMC will now write alarms/alerts into vCenter, which, in turn, will trigger vMotion.

VMware uses the term “setting a server into Maintenance mode” to trigger the vMotion. It is called this because before performing maintenance on server, the data center manager needs to clear the Virtual Machines from the server.

Understanding Maintenance Mode

Both standalone hosts, and hosts within a cluster, support the maintenance mode. Only VMware ESX/ESXi Server 3.0 and later supports maintenance mode for standalone hosts.

A host enters or leaves maintenance mode only as the result of a user request. If the host is in a cluster when it enters maintenance mode, the user is given the option to evacuate powered-off virtual machines. If this option is selected, each powered-off virtual machine is migrated to another host, unless there is no compatible host available for the virtual machine in the cluster. While in maintenance mode, the host does not allow deployment or “power-on” of a virtual machine. Virtual machines that are running on a host entering maintenance mode need to be either migrated to another host or shut down (either manually or automatically by DRS).

When no more running virtual machines are on the host, the host's icon changes to include 'under maintenance' designation and the host's Summary panel indicates the new state. The default automation mode of a virtual machine determines its behavior when the host (in a DRS cluster) it is running on enters maintenance mode:

Any fully automated virtual machine is migrated automatically.

For a partially automated or manual virtual machine, a recommendation for further user action is generated and displayed.

Configuring Maintenance Mode Behavior in vCenter

To configure the maintenance mode feature behavior, we provide here a simple configuration example: Enable the DRS in “Fully Automated” automation level with following steps:

- 1 Open the vCenter server in a vSphere client.
- 2 Right-click and select **Cluster > Edit Setting > Turn on VMware DRS**. Click on next with all default values.

NOTE: With this example, you choose to move all the virtual machines from this server to another server of the same cluster. You can also define other behaviors according to your needs

Configuration Test

To test the installation, please perform a power failure on the UPS and check on vSphere client that the corresponding ESX/ESXi host enters in Maintenance mode after the “Maintenance mode timer.”

VMware vCenter High Availability

After the High Availability (HA) Cluster feature is enabled, VMware disables the automatic startup and shutdown functionality when a hypervisor is shut down.

Dell MUMC features for HA mode:

- Dell MUMC will continue to move the VM from one server to the others, if all servers are powered by different UPSs with different power source (see Figure 99).

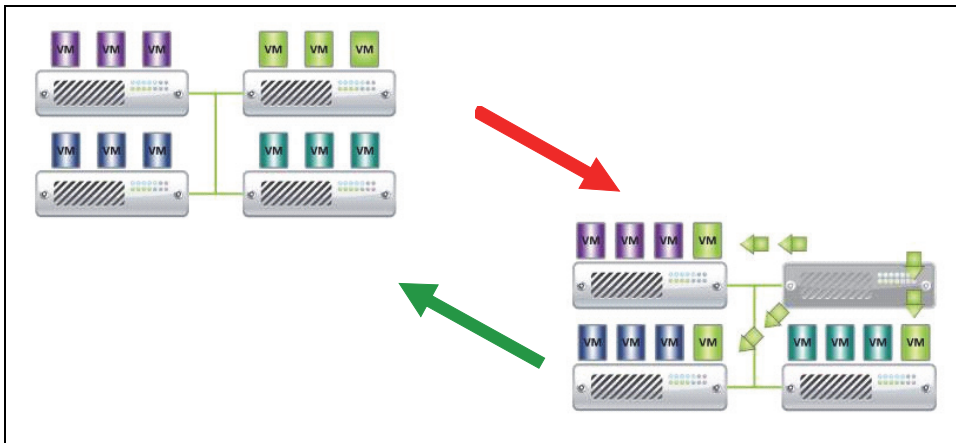

Figure 99. HA Mode with Dell MUMC

Dell MUMC continues to protect the hypervisor also when power fails.

Due to the deactivation of the automatic startup and shutdown, at the end of utility failure sequence, all virtual machines will power-off.

To prevent this VM from powering off, you have two solutions:

- Configure the VMware ESX/ESXi nodes in Dell MUMC to shut down the VMs (remote shutdown of the virtual machine setting).
- Install a Dell MUMC on each VM, even if it is not an optimized solution. You have to take care that when VMs move, the Dell MUMC still links to the same UPS power source.

NOTE: For more information about the deactivation of the Automatic Startup/Shutdown when creating a VMware HA Cluster, refer to “Creating a vSphere HA Cluster” in the links provided by “vSphere SDK for Perl” on page 117.

Configuring Maintenance Mode and Live Migration with SCVMM

Maintenance Mode

In Virtual Machine Manager (VMM) 2008 R2, you can start maintenance mode for a virtual machine host anytime that you need to perform maintenance tasks on the physical host, such as applying security updates or replacing hardware on the physical host computer.

When you start maintenance mode on a Windows-based host, VMM automatically does the following:

- On a stand-alone host, places all running virtual machines into a saved state.
- On a Windows-based host cluster that is capable of live migration, gives you the option to do one of the following:
 - Live migrate all running highly available virtual machines to other hosts in the cluster, and place any running virtual machines that are not highly available in a saved state.
 - Place all running virtual machines into a saved state.

NOTE: Refer to Microsoft® Hyper-V™ reference on page 117.

Understanding Live Migration

Live migration is a Hyper-V feature in Windows Server 2008 R2, which requires the failover clustering feature to be added and configured on the servers running Hyper-V. Live migration allows you to transparently move running virtual machines from one node of the failover cluster to another node in the same cluster without a dropped network connection or perceived downtime.

In addition, failover clustering requires shared storage for the cluster nodes. This can include an iSCSI or Fiber-Channel Storage Area Network (SAN). All virtual machines are stored in the shared storage area, and the running virtual machine state is managed by one of the nodes.

NOTE: Refer to the Hyper-V reference links on page 117.

Configuration Test

To test the installation, please perform a power failure on the UPS and check on Microsoft System Center Virtual Machine Manager (SCVMM) console that the corresponding Hyper-V host enters in Maintenance mode after the “Maintenance mode timer.”

Hyper-V machines have to be started before the machine that is hosting the SCVMM. The SCVMM service needs some time to refresh its status. If the starting sequence is not correct, the Hyper-V will stay in Maintenance mode

VMware References

Dell and Virtualization

- <http://content.dell.com/us/en/enterprise/virtualization>

VMware ESX Configuration

- <http://www.vmware.com/support/>

vCenter Server (VMware Supervisor)

- Visit <http://www.vmware.com/products/vcenter/> for more information about download and installation of vCenter Server.
- Visit also <http://www.vmware.com/products/drs/> for more information about Distributed Resource Scheduler.

vSphere SDK for Perl

- Visit <http://www.vmware.com/support/developer/viperltoolkit/> for more information about download and installation of vSphere SDK for Perl.
- Visit http://pubs.vmware.com/vsphere-50/index.jsp?topic=%2Fcom.vmware.vsphere.avail.doc_50%2FGUID-E90B8A4A-BAE1-4094-8D92-8C5570FE5D8C.html for more information about creating a vSphere HA Cluster.

Microsoft Hyper-V References

Dell and Virtualization

- Visit <http://content.dell.com/us/en/enterprise/virtualization>

Microsoft TechNet Library

- See the Microsoft TechNet Library for more information: <http://technet.microsoft.com/en-us/library/default.aspx>

About Maintenance Mode

- Visit <http://technet.microsoft.com/en-us/library/ee236481.aspx>

Requirements for Using Live Migration

- Visit "Hyper-V Live Migration FAQ": <http://technet.microsoft.com/en-us/library/ff715313%28WS.10%29.aspx>